

SATA HDD Duplicator Controller

User's Manual

— Version: 1.9 —

Attention:

Wait over 5 seconds to power on after shutdown to prevent abnormal operation of the system.

ACARD
TECHNOLOGY

Copyright©2015 ACARD Technology Corp.

Release: August 2015



Copyright and Trademarks

The information of the products in this manual is subject to change without prior notice and does not represent a commitment on the part of the vendor, who assumes no liability or responsibility for any errors that appear in this manual.

ACARD and SCSIDE are the trademarks of ACARD Technology Corp.

This manual contains materials protected under International Copyright Laws. All rights reserved. No part of this manual may be reproduced, transmitted or transcribed without the expressed written permission of the manufacturer and author of this manual.

ACARD's SATA HDD Duplicator Controller is used for copying and editing personal audio and video data. Violating Copy Right is a criminal act. ACARD's Duplicator Controller only supports legal backup operation.

ACARD Technology Corp. is not responsible for illegal recording.

Table of Contents

Chapter 1 Introduction	7
1.1 Overview	7
1.2 Features	7
1.3 Specifications	7
1.4 Package & Component	7
Chapter 2 Installation	8
2.1 Install ARS-2051F	8
2.2 Install ARS-5503M / 5503H	11
2.3 Install ARS-2055PF	14
2.4 Install ARS-5505E / 5505M / 5505H	17
2.5 Install ARS-5509M	20
2.6 Install ARS-2061F	23
Chapter 3 Basic Instructions	26
3.1 Buttons and LCD	26
3.2 LCD Configuration Chart	26
Chapter 4 Board Layout	27
Chapter 5 Functions	32
5.1 Copy HDD	35
5.2 Async Copy HDD	35
5.3 Compare HDD	35
5.4 Async Compare	36
5.5 PreScan Source	37
5.6 ReScan BUS	37
5.7 Source Size	37
5.8 Secure Erase	38
5.9 Overwrite	38
5.10 Setup	39
5.10.1 Language	39
5.10.2 Copy Size	39
5.10.3 Startup Menu	39
5.10.4 Auto Compare	39
5.10.5 Button Sound	40
5.10.6 Device Info	40
5.10.7 System Info	40

5.10.8	Fast Copy	40
5.10.9	Auto Start Drive	41
5.10.10	Auto Start Timer	41
5.10.11	Tolerance Size	41
5.10.12	BootTime Delay	41
5.10.13	Quick Compare	42
5.10.14	Copy with size	42
5.11	Last Log	42
5.12	Adv Setup	43
5.12.1	Read Error Skip	43
5.12.2	Update Firmware	44
5.12.3	Compare Firmware	44
5.12.4	Quick Erase HDD	44
5.12.5	Full Erase HDD	45
5.12.6	H/W Diagnostic	45
5.12.7	Load Default	46
5.12.8	Copy HPA	46
5.12.9	Burn In	46
5.12.10	Detect HDD Delay (ARS-2051F Only)	47
5.12.11	Link Option (ARS-2051F Only)	47
5.12.12	USB Auto-Link (ARS-2051F Only)	47
5.13	USB Mode (ARS-2051F Only)	48
Chapter 6	Basic Troubleshooting	49
6.1	LCD	49
6.2	Error Message	49
6.3	Hard Disk	49
6.4	Keys	49
6.5	Firmware Upgrade	49
6.6	Startup/Shutdown	49
6.7	About Copy HPA	49
Appendix A	Error Messages List	50
Appendix B	Firmware Update via HDD / USB	51
Appendix C	SATA Port Locate&Define	52
Appendix D	ARS-2051F with AEC-4420DX installation	54
Technical Support Form		59



WEEE Statement

In order to cope with the increasing waste electrical and electronic equipment, reduce the use of landfill and incinerator, and prevent the harmful matter of waste equipment from entering the environment, the European Union (EU) has set the Directive on Waste Electrical and Electronic Equipment (WEEE) asking manufacturers to collect, recycle and treat waste electrical and electronic equipment properly. Member nations already established their free of charge recycle systems of WEEE before August 13, 2005. Accordingly, ACARD has to be responsible for recycling all products exported to Germany. You can return your ACARD product that needs recycling to a local collector.

WEEE Erklärung

Mit dem Ziel die steigende Menge elektrischer und elektronischer Altgeräte zu bewältigen ohne hierzu unnötig Mülldeponien und Verbrennungsanlagen zu belasten und um die Verschmutzung der Umwelt durch freiwerdende Stoffe aus den Altgeräten zu vermeiden, hat die Europäische Union (EU) die Richtlinie über Elektro- und Elektronik-Altgeräte erlassen. Die Richtlinie verpflichtet Hersteller, elektrische und elektronische Altgeräte umweltgerecht einzusammeln, zu recyceln und zu entsorgen. Die Mitgliedsstaaten der EU haben bereits ihre kostenfreien Recyclesysteme konform der WEEE vor dem 13. August 2005 eingerichtet. Entsprechend der Richtlinie ist ACARD verantwortlich für die umweltgerechte Entsorgung aller nach Deutschland exportierten ACARD Produkte. Sie können Ihr zu entsorgendes ACARD Produkt zu Ihrer örtlichen Sammelstelle bringen.

AEEA verklaring

Met het doel de stijgende hoeveelheid afgedankte elektrische en elektronische apparatuur te beheersen zonder hiervoor onnodig stortplaatsen en verbrandingsovens te belasten en om de vervuiling van het milieu door vrijkomende stoffen uit de afgedankte apparatuur te voorkomen, heeft de Europese Unie (EU) de richtlijn betreffende afgedankte elektrische en elektronische apparatuur besloten. Deze richtlijn verplicht fabrikanten afgedankte elektrische en elektronische apparatuur in te zamelen, te recycelen en te verwijderen. De lidstaten van de EU hebben reeds de kosteloze recyclesystemen volgens de AEEA vóór de 13 augustus 2005 ingericht. Conform de richtlijn is ACARD verantwoordelijk voor de verwijdering van alle naar Nederland geëxporteerde ACARD producten. U kunt uw afgedankt ACARD product naar uw locale inzamelplaats brengen.

Elektrik ve Elektronik Madde Atıkları Demeci

Elektrik ve elektronik madde atıklarının yükselmesiyle basedebilmek ,arazi doldurma ve çöp yakma fırını kullanımını azaltmak,atık madde zararlarının çevreye yayılmasını onlemek için Avrupa Birliği (AB),ureticilerden elektrik ve elektronik madde atıklarını gerektiği gibi toplamalarını,geri donusturmelerini ve kimyasal isleme tabi tutmalarını talep etmek için Elektrik ve Elektronik Madde Atıkları uzerine bir direktif hazırladı.Topluluk uyeleri,13 Agustos 2005' ten once elektrik ve elektronik madde atıklarının ücretsiz geri donusum sistemlerini coktan olusturmuslardı.Bundan dolayı, ACARD, Almanya'ya ihrac ettiği bütün ürünlerin geri donusumunden sorumludur.ACARD ürünleri geri donusum gerektirirse yerel toplayıcılara geri verebilirsiniz.

WEEE бюлетень

Чтобы справиться с увеличивающимся ненужным электрическим и электронным оборудованием, уменьшите использование закапывания мусора и использования установки для сжигания отходов, препятствуйте вредному выбросам загрязнять окружающую среду, Европейский союз (ЕС) установил Директиву по Ненужному Электрическому и Электронному Оборудованию (WEEE) для того, чтобы изготовителей собрали, перерабатывали и вообще проявили внимание к ненужному электрическому и электронному оборудованию должным образом. Члены нации установили бесплатную систему и электронному оборудованию должным образом. Члены нации установили бесплатную систему переработки WEEE до 13 августа 2005. Соответственно, ACARD обязан быть ответственным за то, что переработал все продукты, экспортируемые в Германию. Вы можете вернуть ваш продукт ACARD, который нуждается в рециркуляции местному сборщику.

WEEE Statement

Afin de gérer la quantité croissante de déchets électriques et électroniques, de réduire l'utilisation des décharges et des incinérateurs et d'éviter que des déchets nocifs ne polluent l'environnement, l'Union Européenne a publié la directive WEEE sur les déchets électriques et électroniques. Celle-ci spécifie que les fabricants doivent collecter, recycler et traiter l'équipement électronique et électrique usagé. Depuis le 13 août 2005, les pays membres ont mis en place un système de recyclage gratuit selon le WEEE,.

De ce fait, Acard est responsable du recyclage de tous les produits exportés vers l'Allemagne. Vous pouvez mettre au rebut votre équipement ACARD usagé dans votre centre local de recyclage.

Pour plus d'informations sur les lieux de mise au rebut des équipements usagés destinés au recyclage, veuillez contacter votre mairie, votre service de traitement des déchets ménagers ou le magasin où vous avez acheté le produit.

RAEE

Con la finalidad de reducir el incremento de residuos eléctricos y de material electrónico, reduciendo el uso de los vertederos e incineradoras y prevenir el preocupante aumento del contacto de estos residuos con el medio ambiente. Por este motivo la Unión Europea ha fijado la Directiva de Residuos de Aparatos Eléctricos y Electrónicos (RAEE) solicitando a los fabricantes la recolección, reciclaje y tratamiento de estos residuos correctamente. Los países miembros ya han establecido su sistema de reciclaje gratuito de RAEE antes del 13 de Agosto del 2005. Por este motivo ACARD es el responsable del reciclaje de todos los productos exportados a Alemania. Usted puede devolver su producto Acard a un punto de recogida local cuando desee reciclarlo.

Dichiarazione WEEE

Per far fronte all'aumento dei residui delle apparecchiature elettriche ed elettroniche, ridurre l'uso di materiale di riporto e degli inceneritori, ed impedire che il materiale nocivo delle apparecchiature residue entri a contatto con l'ambiente, l'Unione Europea (UE) ha stabilito le Direttive sui Residui delle apparecchiature Elettriche ed Elettroniche (WEEE) chiedendo ai fornitori di raccogliere correttamente, riciclare e trattare le apparecchiature elettriche ed elettroniche residue. Le nazioni facenti parte dell'Unione Europea hanno già stabilito il loro sistema gratuito di riciclaggio di questo materiale (WEEE) prima del 13 agosto 2005. Di conseguenza, ACARD è responsabile del riciclaggio di tutti i prodotti esportati in Germania. Potete restituire il vostro prodotto acquistato da ACARD che deve essere riciclato da un'azienda specifica locale.

Chapter 1 Introduction

1.1 Overview

The nine SATA HDD Duplicator models available are ARS-2051F/5503M/5503H/2055PF/5505E/5505M/5505H/5509M/2061F. The ARS-2051F/5503M/5503H/2055PF/5505E/5505M/5505H/5509M/2061F are standalone 1-to-1, 1-to-3, 1-to-5, 1-to-9, and 1-to-11 SATA HDD duplicators. All are equipped with an LCD display and touch buttons so that HDD data can be duplicated quickly and conveniently without using a computer. This makes them well suited for backing up personal and business data. The IT industry can also use them for small-scale data duplication.

In the past, users looking to duplicate data on to multiple HDDs usually had to start up the computer then use writing software like Ghost. This means time has to be spent on learning to use the software and then using it to copy data. ACARD's answer is the SATA HDD Duplicator series that offers fast data backup.

1.2 Features

- SATA-to-SATA HDD duplicators
- Completely standalone SATA HDD duplicator with no additional hardware or software required.
- Support for high-speed 1-to-1 (ARS-2051F), 1-to-3 (ARS-5503M/5503H), 1-to-5 (ARS-2055PF/5505E/5505M/5505H), 1-to-9 (ARS-5509M) or 1-to-11 (ARS-2061F) HDD duplication
- User-friendly interface with LCD information display
- Offers a range of options that extend the product's applications

1.3 Specifications

- ACARD SoC processor
- 8MB (ARS-2051F), 64MB (ARS-2055PF) or 128MB (ARS-5503M/5503H/5505E/5505M/5505H/5509M/2061F) SDRAM memory
- 2 SATA interfaces (ARS-2051F), 4 SATA interfaces (ARS-5503M/5503H), 6 SATA interfaces (ARS-2055PF/5505E/5505M/5505H), 10 SATA interfaces (ARS-5509M), 12 SATA interfaces (ARS-2061F)
- 2 x16 LCD display
- Thin film 4 button controls
- 256KB (ARS-2051F), 1024KB (ARS-2055PF/2061F/5503M/5503H/5505E/5505M/5505H/5509M) of FLASH memory for Copy Code
- Firmware upgradeable via CD/DVD/HDD/USB port
- Power - Voltage: 5V±5%
Current: 1.5A (max.)
- Environment - Operating: 0°C~60°C
Non-Operating: -20°C~85°C
- Humidity - 15%~90%
- Dimensions - 150mm (W) x 42mm (H) x 150mm (D)

1.4 Package & Component

- ARS-2051F/ ARS-5503M/ARS-5503H/ARS-2055PF/ARS-5505E/ ARS-5505M/ARS-5505H/ ARS-5509M/ARS-2061F x 1
- Quick Installation Guide x 1
- Support CD x 1
- SATA Cable x 2 (2051F), SATA Cable x 6 (2055PF/5505E/5505M/5505H), SATA Cable x 10 (5509M), SATA Cable x 12 (2061F)
- USB Cable x 1 (Not for 2051F/2055PF/2061F PCB:5.2)
- Screw Bag x 1

Chapter 2 Installation

Please verify that the product includes all required accessories and the necessary equipment are available before installation.

2.1 Install ARS-2051F

The ARS-2051F is shown on the right:

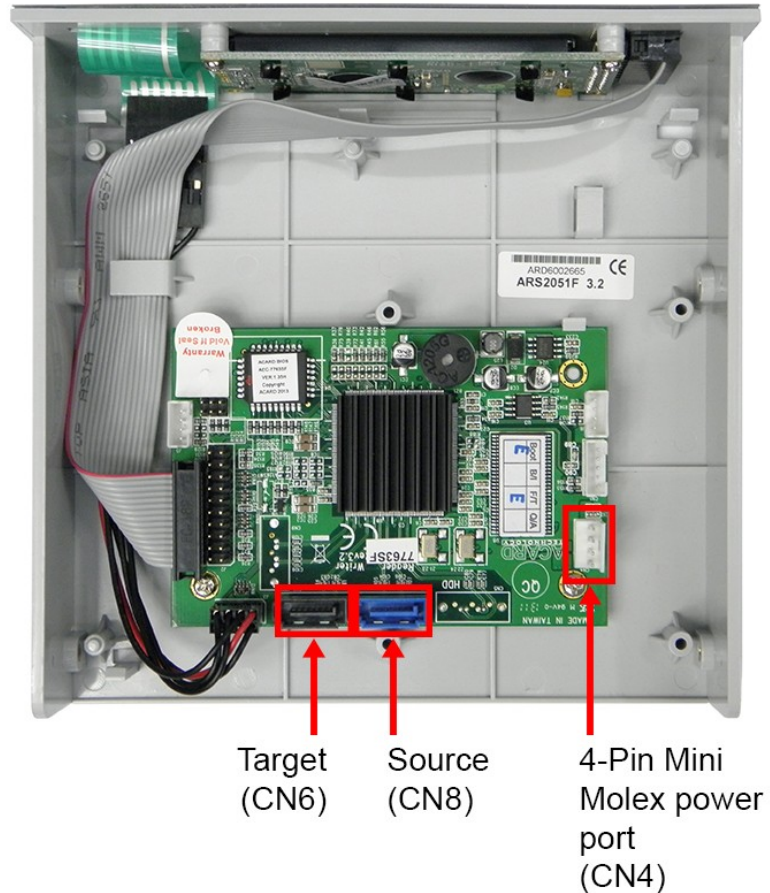

Before Installation

Before connecting the power, please verify that your power supply has enough wattage to operate the controller and all the HDDs/SSDs. The capacity of the target HDD/SSD must be greater than or equal to that of the source HDD/SSD. The ARS-2051F includes two SATA ports: CN8 is the blue source port and CN6 is the black target port. Please follow the steps below to configure your HDD/SSD duplicator setup.

Installation Procedure

1. Connect the source HDD/SSD with the orange SATA cable into the SATA CN8 blue port on the ARS-2051F. Connect the opposite end of the cable into the source HDD/SSD SATA port:

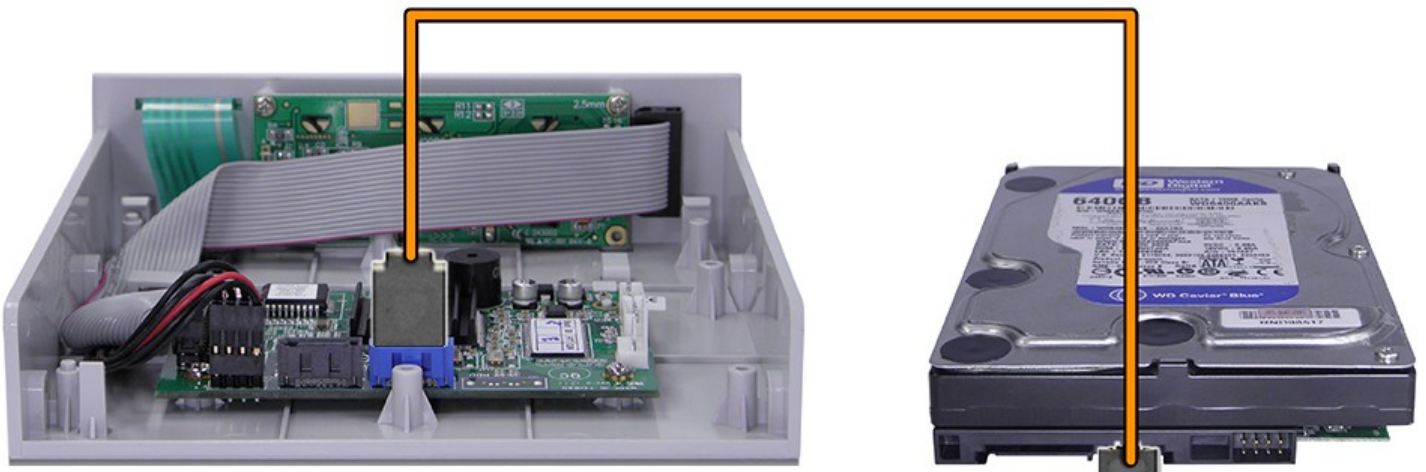

*SATA cable colors are for demonstration purposes only, supplied may consist of all red or all orange cables.

2. Connect the target HDD/SSD with the red SATA cable into the SATA CN6 black port on the ARS-2051F. Connect the opposite end of the cable into the target HDD/SSD SATA port:

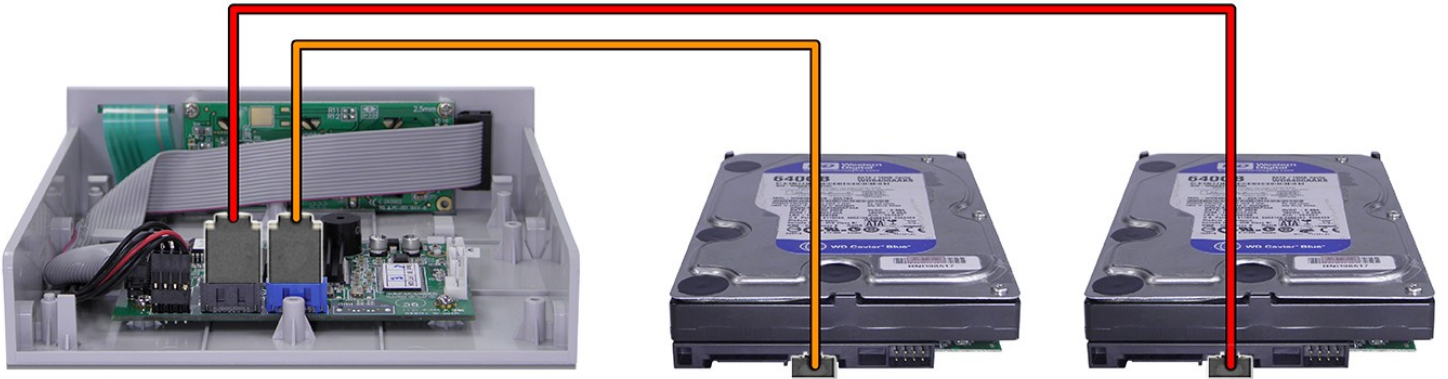

3. Connect the female mini molex 4-pin power cable into the ARS-2051F male molex 4-pin port (CN4):

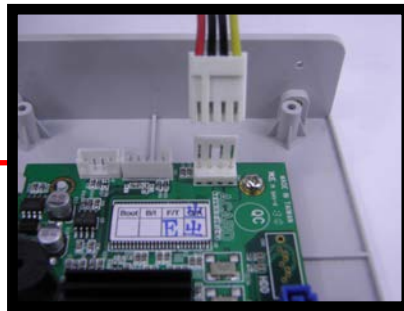
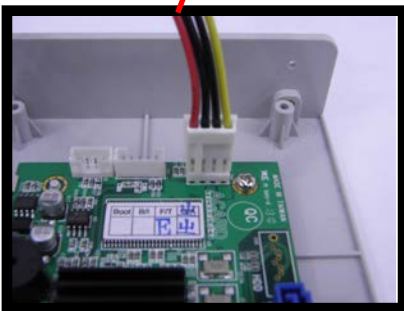

4. Please mate the remaining female SATA power cables into the HDDs/SSDs source and target male SATA power ports:

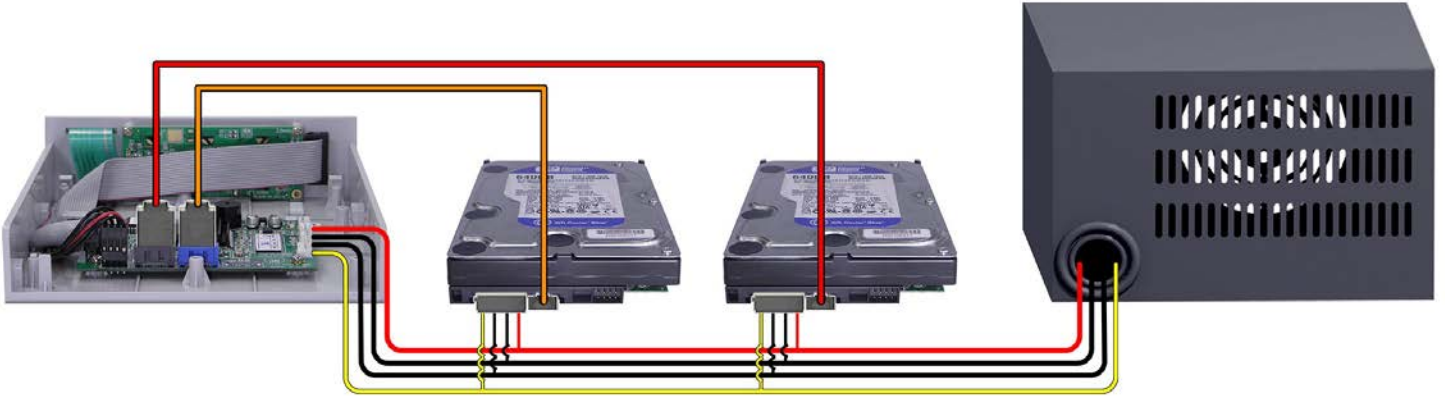

5. The power supply unit can now be switched on (plug into the wall outlet) to boot your copy controller and supply power to your HDDs/SSDs.

Shown below is a ARS-2051F controller with all the SATA and power cables properly configured to the source HDD/SSD, target HDD/SSD and power supply unit:

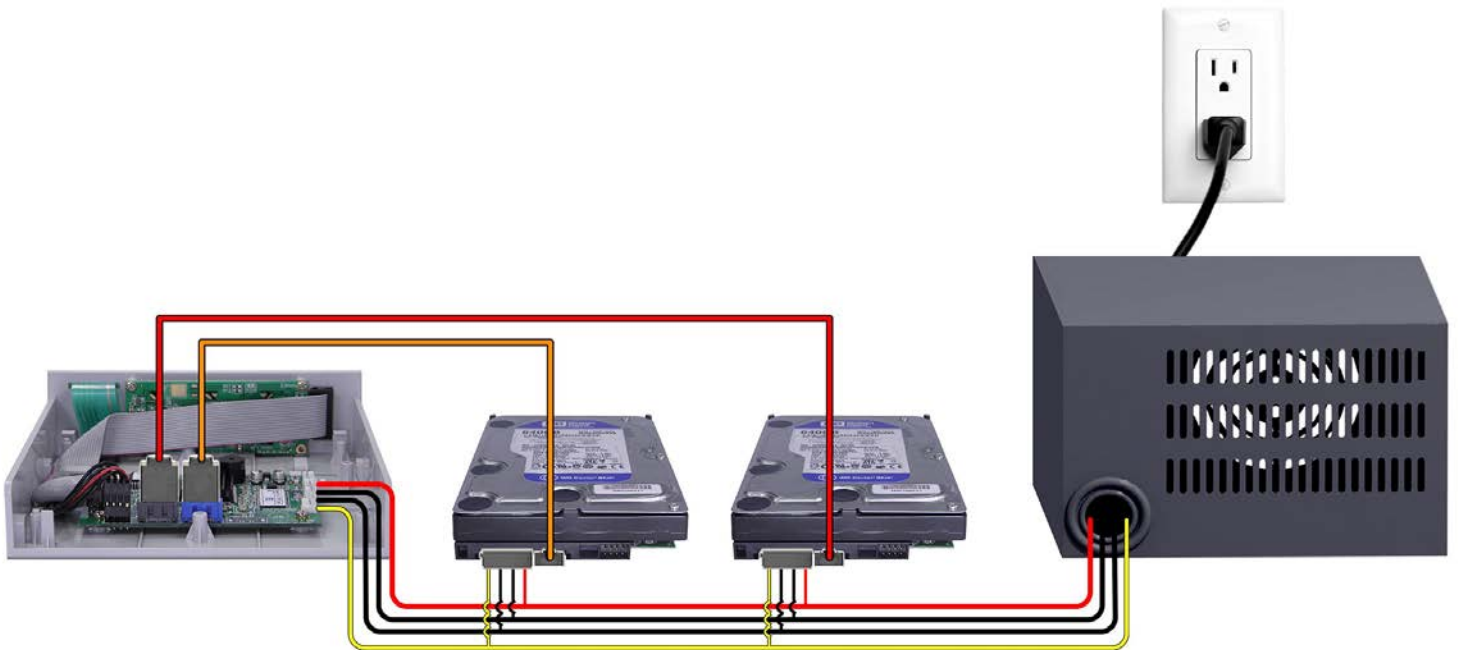

*SATA cable colors are for demonstration purposes only, supplied may consist of all red or all orange cables.

**The displayed HDDs are stacked for demonstration purposes only. Please DO NOT stack HDDs on top of each other as it will cause damages. We highly suggest you use a duplicator tower.

2.2 Install ARS-5503M / 5503H

The ARS-5503M / 5503H is shown below:

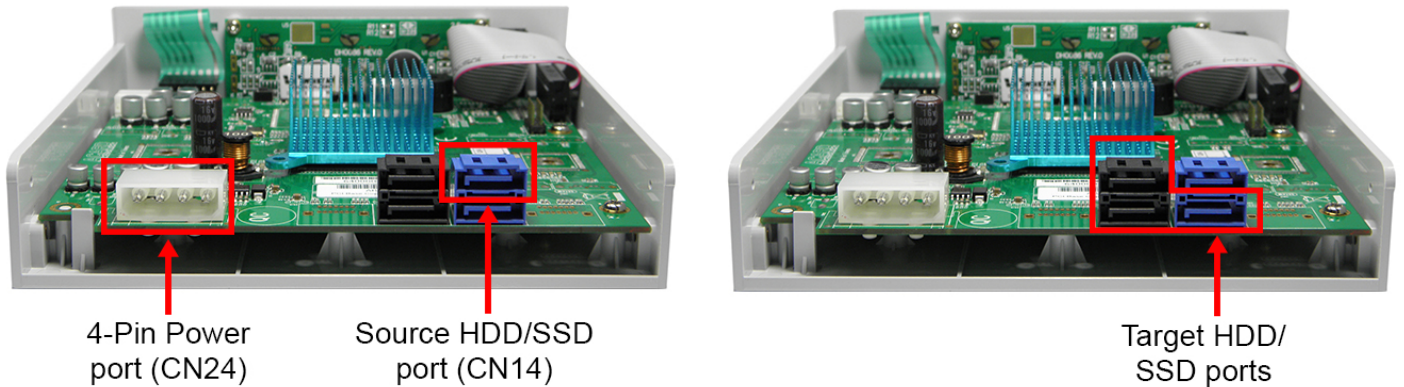

Before Installation

Before connecting the power, please verify that your power supply has enough wattage to operate the controller and all the HDDs/SSDs. The capacity of the target HDDs/SSDs must be greater than or equal to the source HDD/SSD. The ARS-5503M/5503H includes four SATA ports: the top blue source port, one bottom blue target port and two black target ports. Please follow the steps below to configure your HDDs/SSDs duplicator setup.

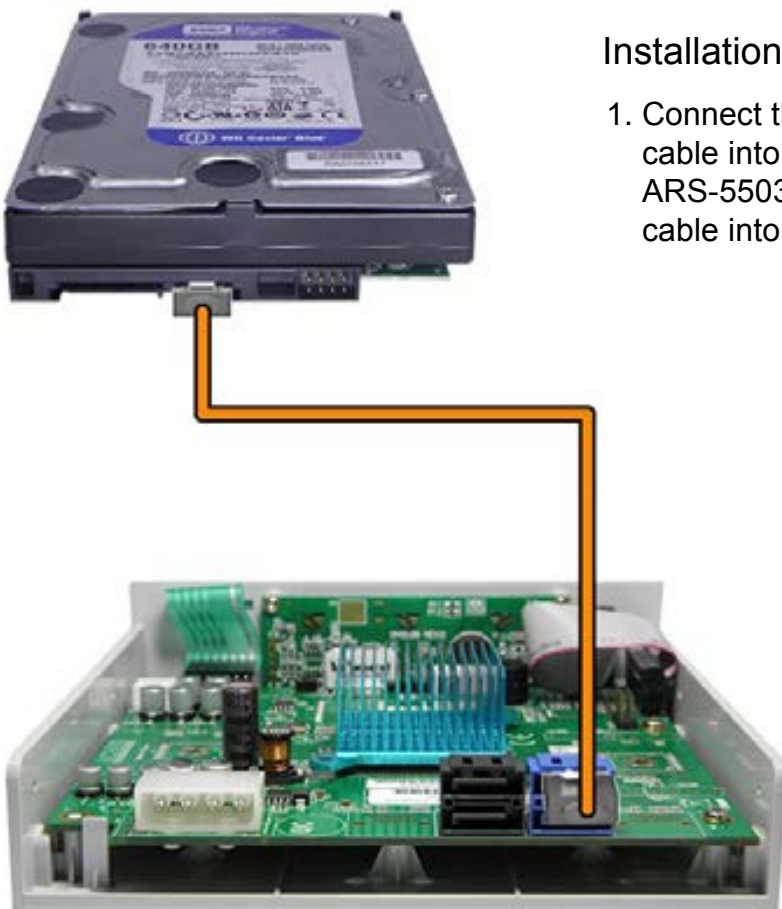

Installation Procedure

1. Connect the source HDD/SSD with the orange SATA cable into the SATA CN14 top blue port on the ARS-5503M/5503H. Connect the opposite end of the cable into the source HDD/SSD SATA port:

*SATA cable colors are for demonstration purposes only, supplied may consist of all red or all orange cables.

2. Connect the target HDDs/SSDs with the red SATA cables into the bottom blue SATA port and the two other black SATA ports on the ARS-5503M/5503H. Connect the opposite end of the cables into the target HDDs/SSDs SATA ports:

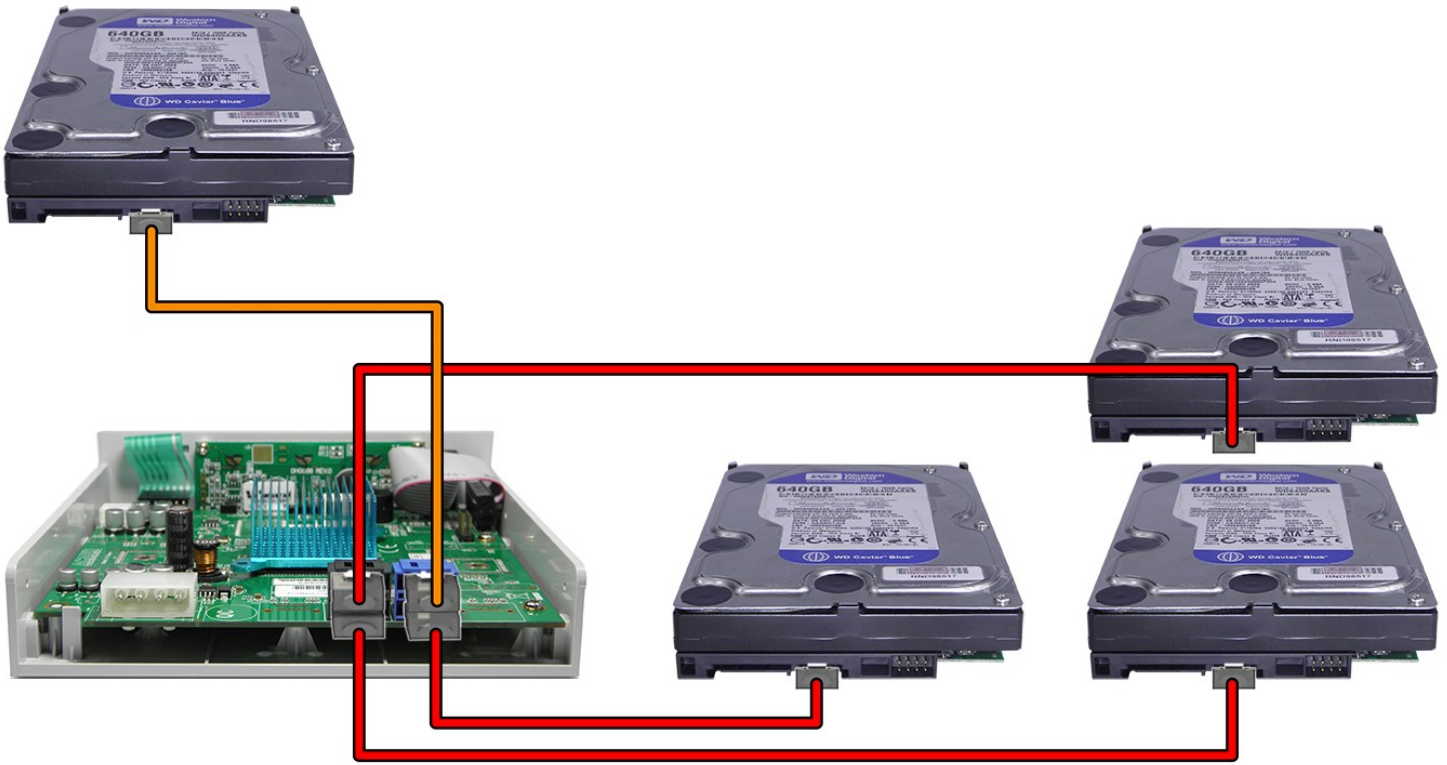

3. Connect the female moxex 4-pin power cable into the ARS-5503M/5503H male moxex 4-pin port (CN24):

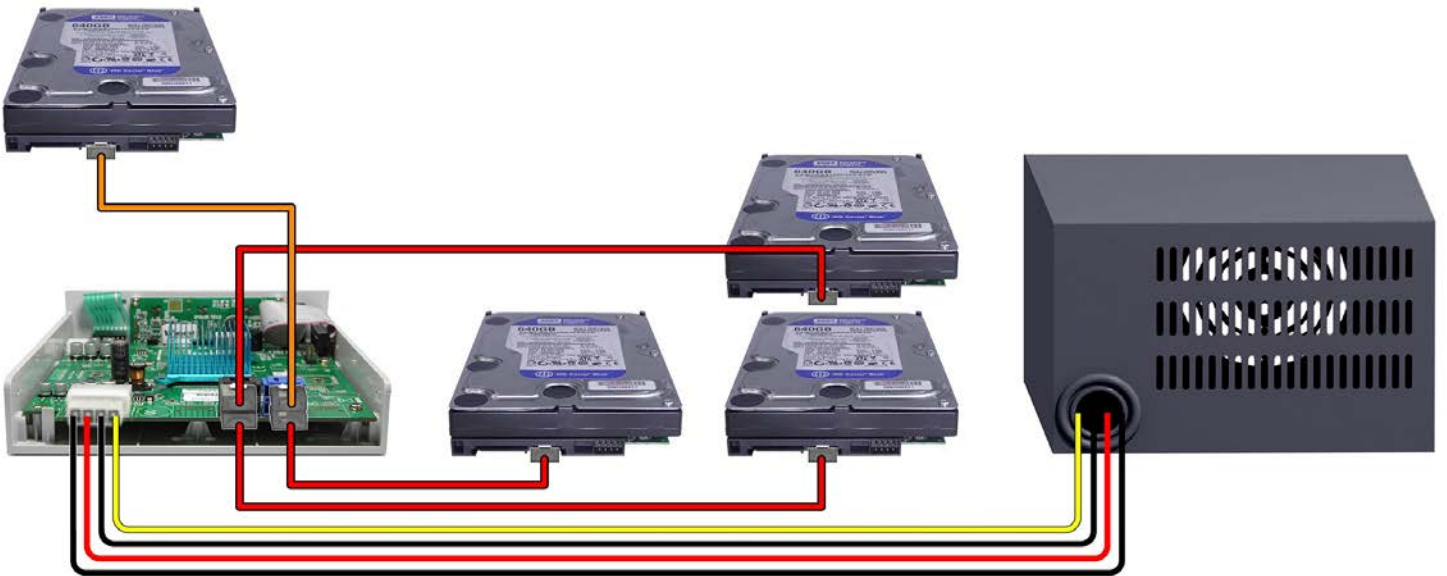

4. Please mate the remaining female SATA power cables into the HDDs/SSDs source and target male SATA power ports:

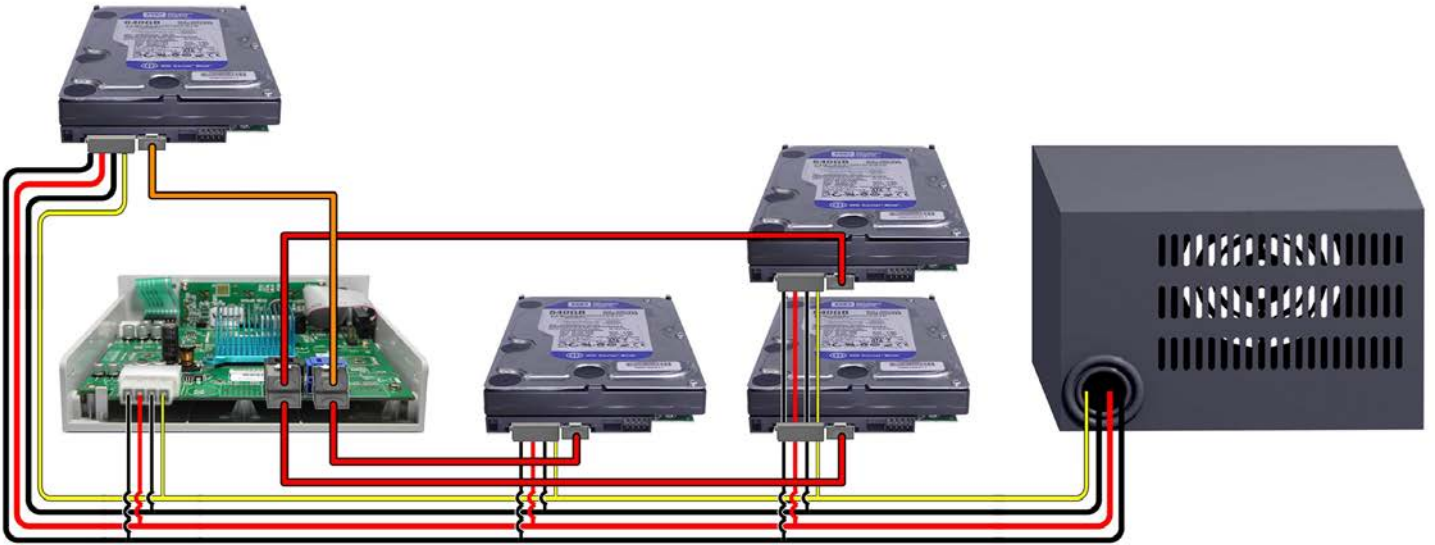

5. The power supply unit can now be turned on (plug into the wall outlet) to boot your copy controller and supply power to your HDDs/SSDs.

Shown below is a ARS-5503M/5503H with all the SATA and power cables properly configured to the source HDD/SSD, target HDDs/SSDs and power supply unit:

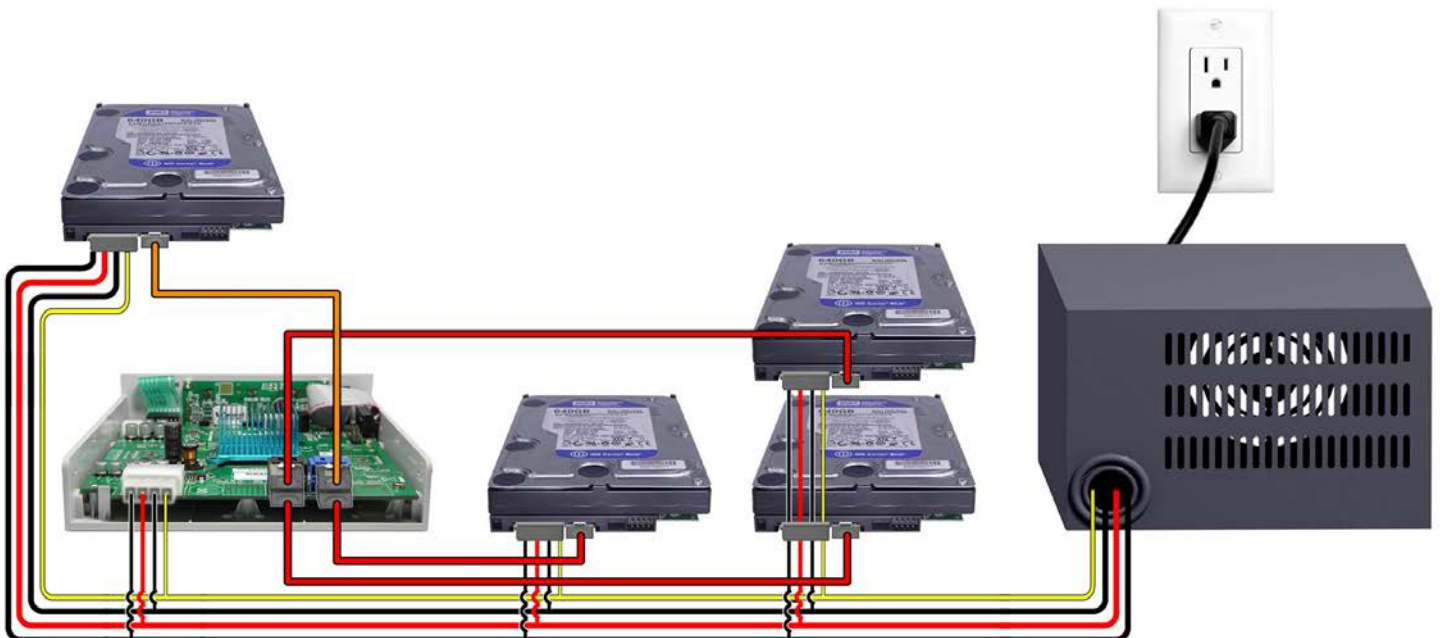

*SATA cable colors are for demonstration purposes only, supplied may consist of all red or all orange cables.

**The displayed HDDs are stacked for demonstration purposes only. Please DO NOT stack HDDs on top of each other as it will cause damages. We highly suggest you use a duplicator tower.

2.3 Install ARS-2055PF

The ARS-2055PF is shown below:

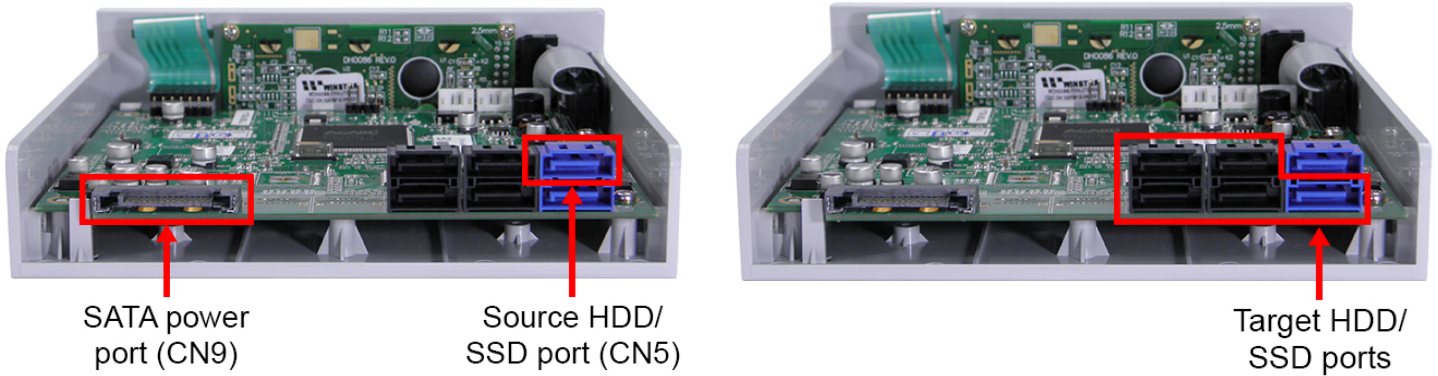

Before Installation

Before connecting the power, please verify that your power supply has enough wattage to operate the controller and all the HDDs/SSDs.. The capacity of the target HDDs/SSDs must be greater than or equal to that of the source HDD/SSD. The ARS-2055PF includes six SATA ports: the top blue source port, one bottom blue target port and four black target ports. Please follow the steps below to configure your HDDs/SSDs duplicator setup.

Installation Procedure

1. Connect the source HDD/SSD with the orange SATA cable into the SATA CN5 top blue port on the ARS-2055PF. Connect the opposite end of the cable into the source HDD/SSD SATA port:



*SATA cable colors are for demonstration purposes only, supplied may consist of all red or all orange cables.

2. Connect the target HDDs/SSDs with the red SATA cable into the bottom blue SATA port and the four black SATA ports on the ARS-2055PF. Connect the opposite end of the cables into the target HDDs/SSDs SATA ports:

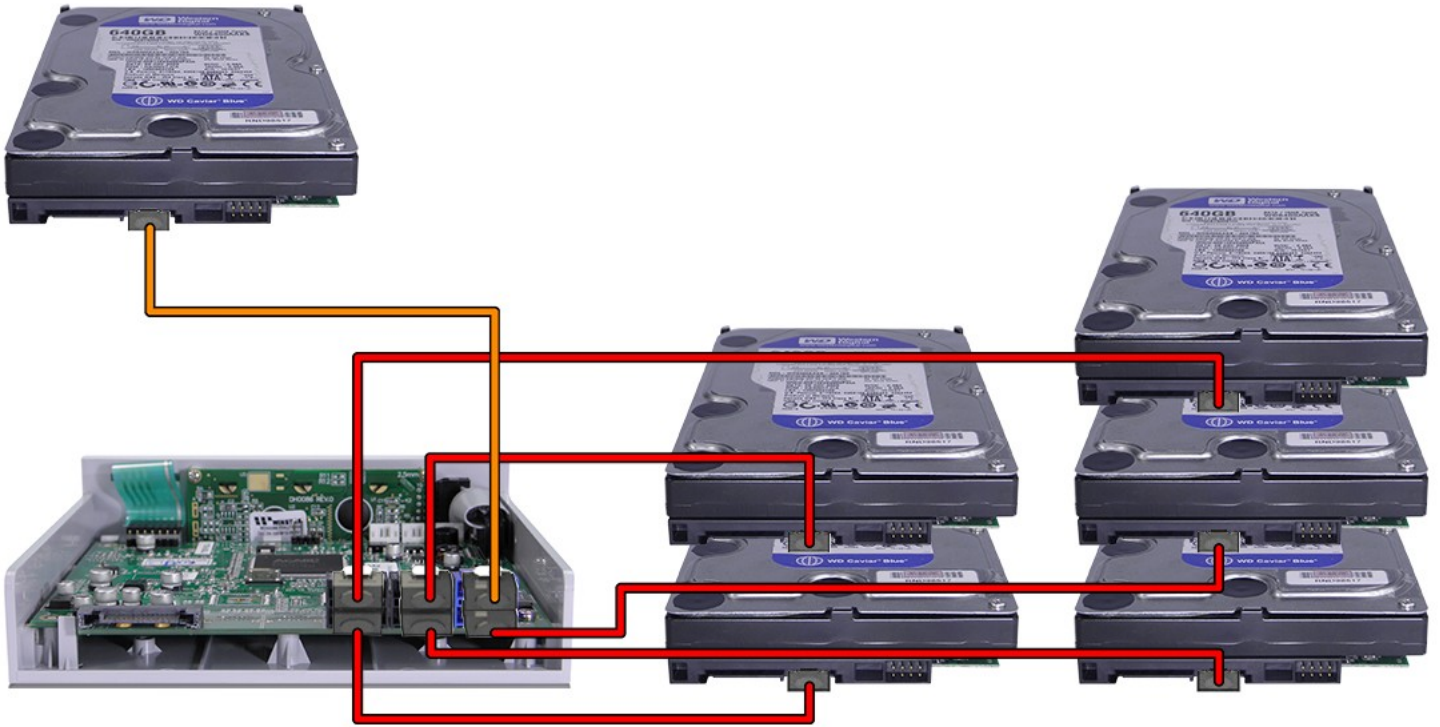

*The displayed HDDs are stacked for demonstration purposes only. Please DO NOT stack HDDs on top of each other as it will cause damages. We highly suggest you use a duplicator tower.

3. Please orient and mate the copy controller L-shape female SATA power cable to its L shape male SATA power connection on the controller's PCB:



4. Please mate the remaining female SATA power cables into the HDDs/SSDs source and target male SATA power ports:



5. The power supply unit can now be turned on (plug into the wall outlet) to boot your copy controller and supply power to your HDDs/SSDs.

Shown below is a ARS-2055 PF controller with all the SATA and power cables properly configured to the source HDD/SSD, target HDDs/SSDs and power supply unit:



*SATA cable colors are for demonstration purposes only, supplied may consist of all red or all orange cables.

**The displayed HDDs are stacked for demonstration purposes only. Please DO NOT stack HDDs on top of each other as it will cause damages. We highly suggest you use a duplicator tower.

2.4 Install ARS-5505E / 5505M / 5505H

The ARS-5505E / 5505M / 5505H is shown below:

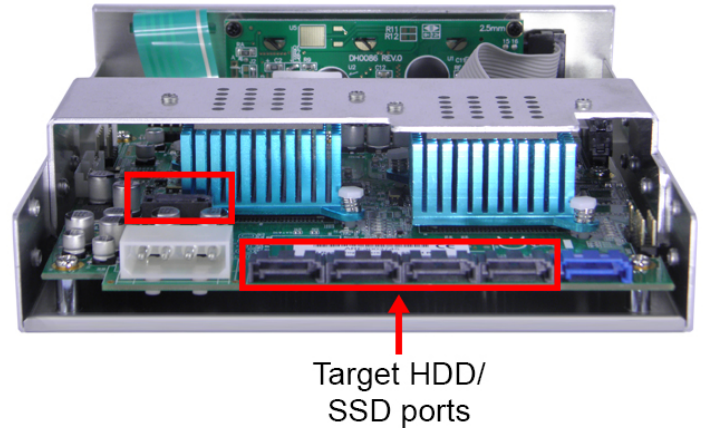
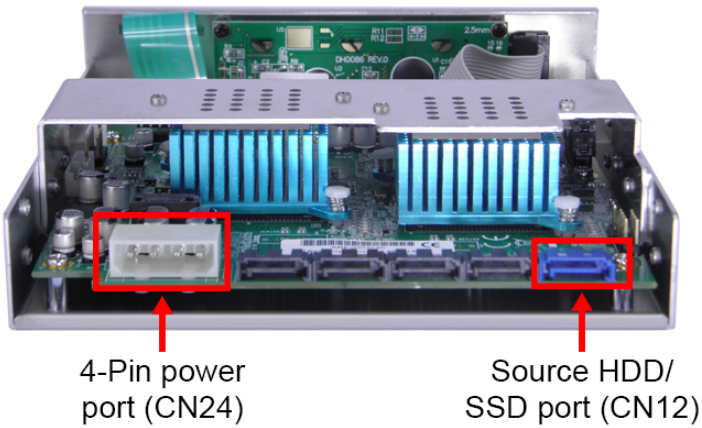

Before Installation

Before connecting the power, please verify that your power supply has enough wattage to operate the controller. The capacity of the target HDDs/SSDs must be greater than or equal to that of the source HDD/SSD. The ARS-5505E/5505M/5505H includes six SATA ports: the blue source port and five black target ports. Please follow the steps below to configure your HDDs/SSDs duplicator setup.

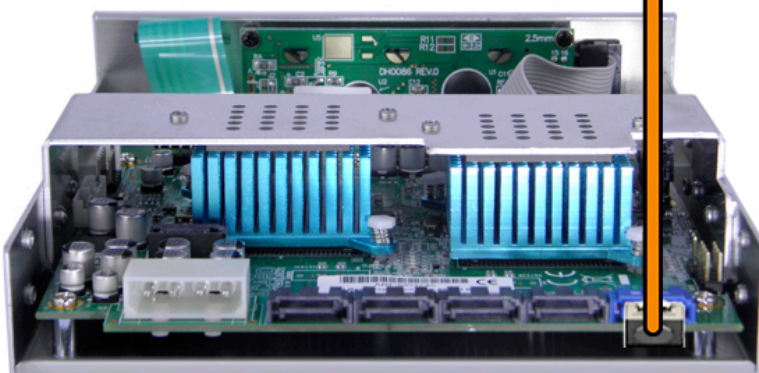
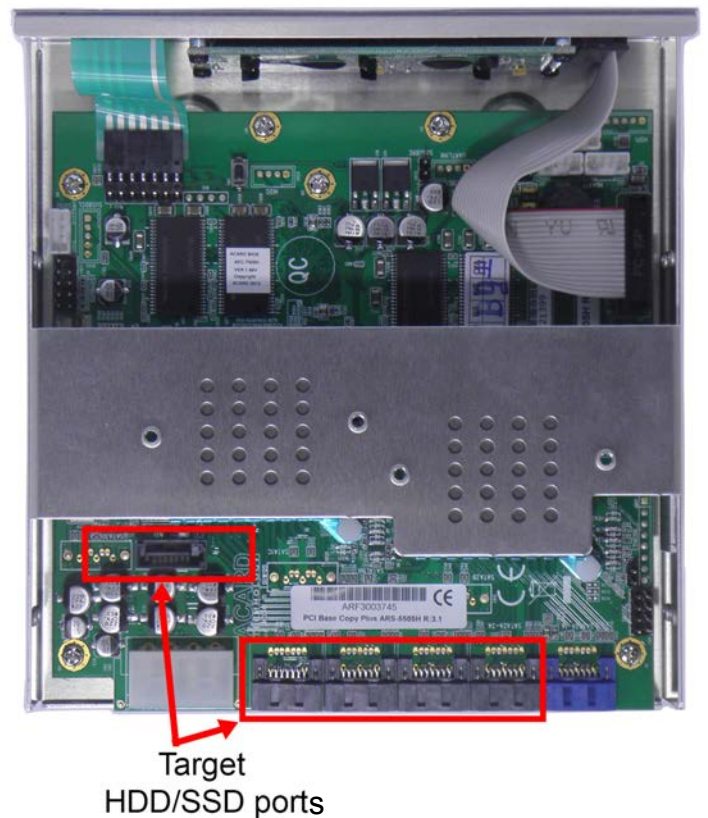

Installation Procedure

1. Connect the source HDD/SSD with the orange SATA cable into the SATA CN12 blue port on the ARS-5505E/5505M/5505H. Connect the opposite end of the cable into the source HDD/SSD SATA port:

*SATA cable colors are for demonstration purposes only, supplied may consist of all red or all orange cables.

2. Connect the target HDDs/SSDs with the red SATA cable into the SATA black ports on the ARS-5505E/5505M/5505H. Connect the opposite end of the cables into the target HDDs/SSDs SATA ports:

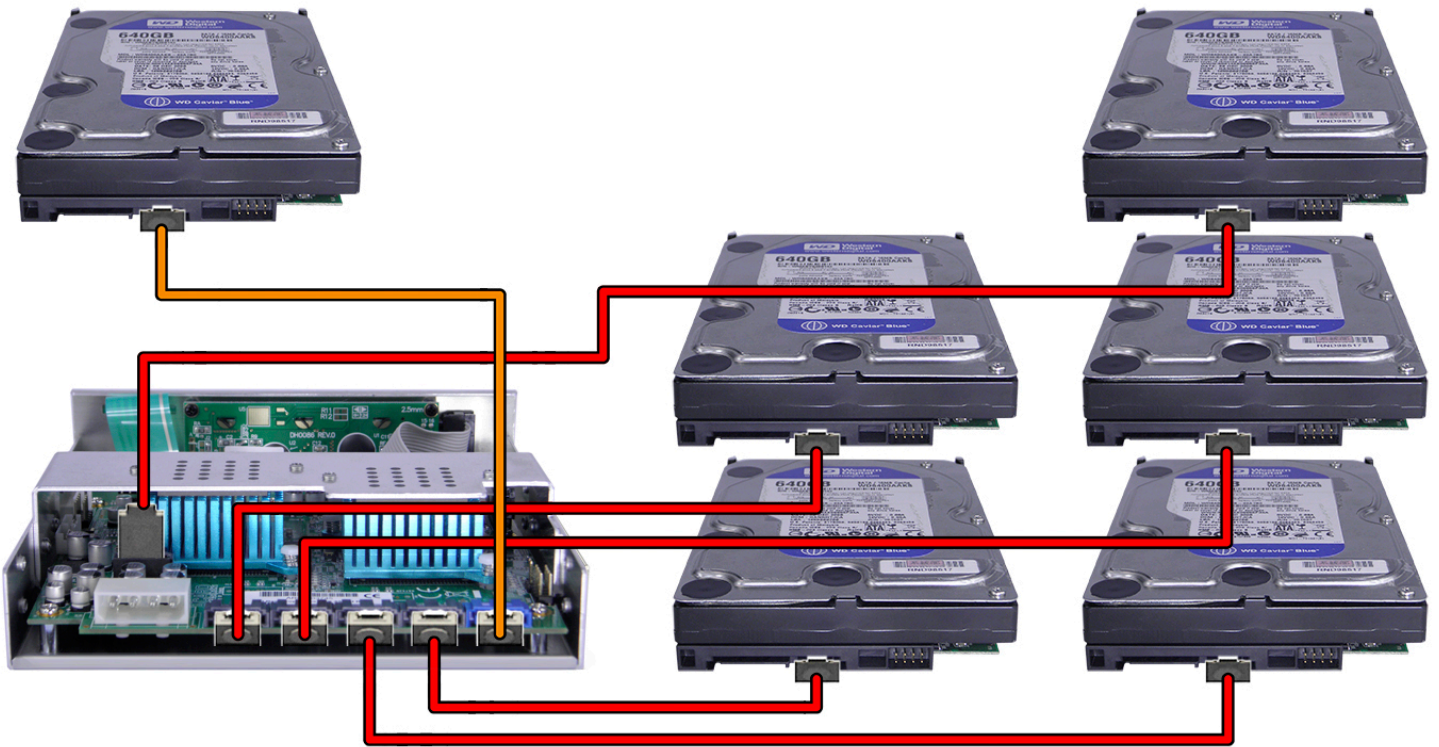

*The displayed HDDs are stacked for demonstration purposes only. Please DO NOT stack HDDs on top of each other as it will cause damages. We highly suggest you use a duplicator tower.

3. Connect the female moxex 4-pin power cable into the male moxex 4-pin power port on the ARS-5505E/5505M/5505H:

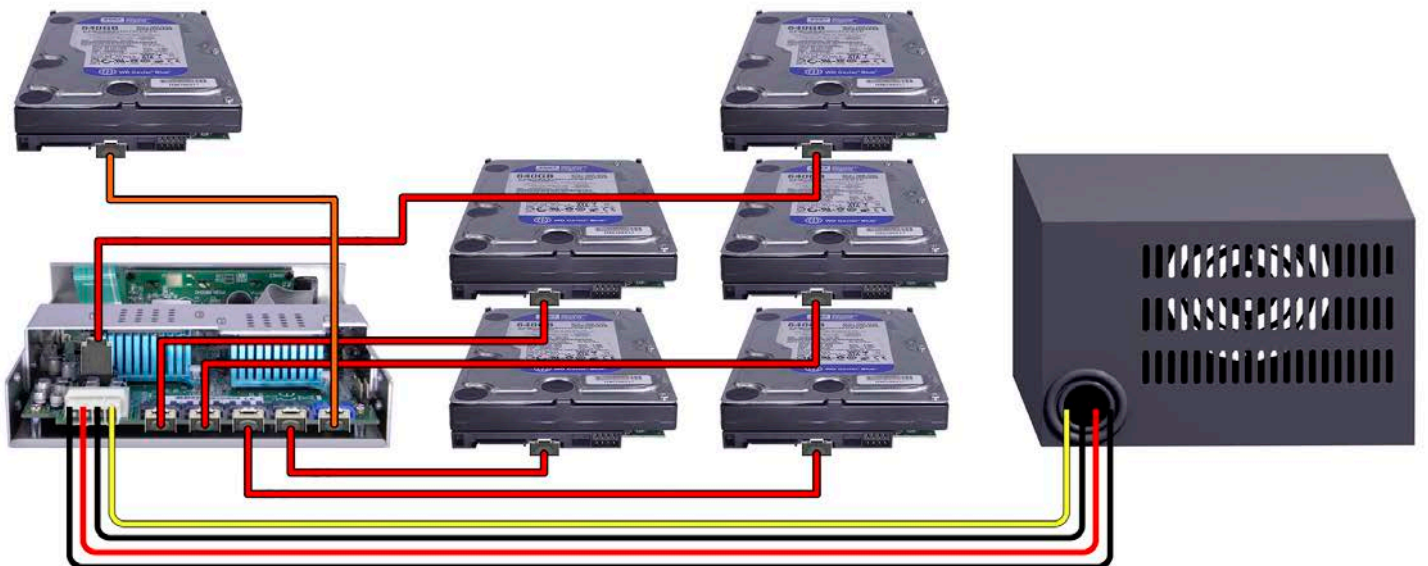

4. Please mate the remaining female SATA power cables into the HDDs/SSDs source and target male SATA power ports:

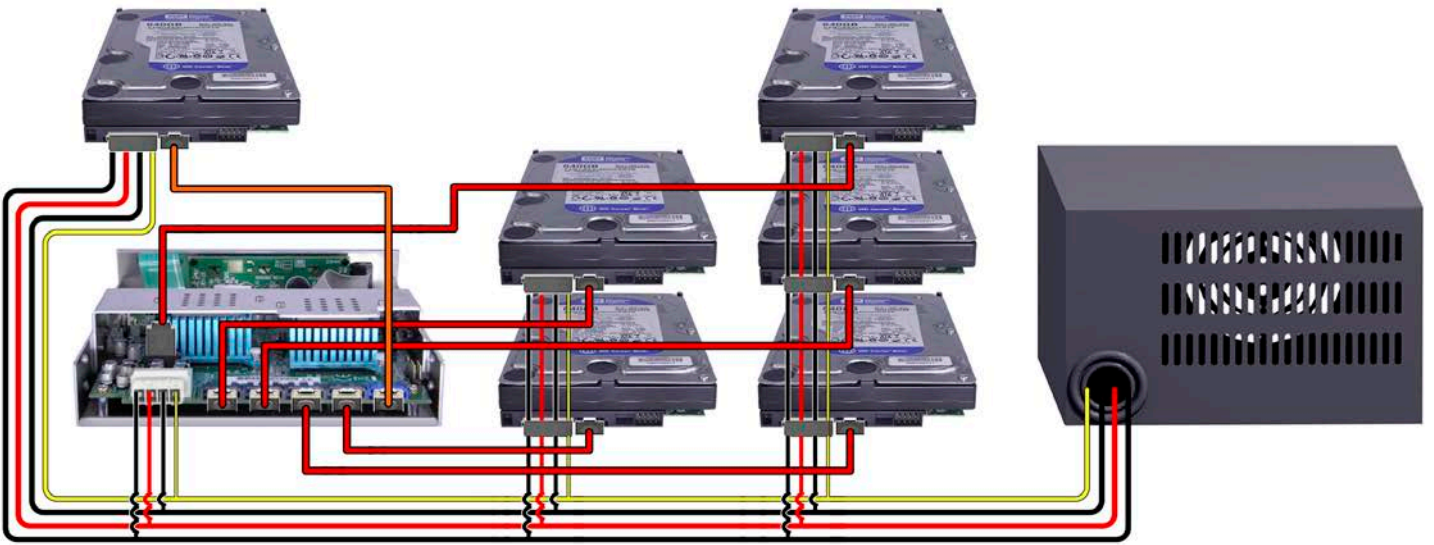

5. The power supply unit can now be turned on (plug into the wall outlet) to boot your copy controller and supply power to your HDDs/SSDs.

Shown below is a ARS-5505H controller with all the SATA and power cables properly configured to the source HDD/SSD, target HDDs/SSDs and power supply unit:

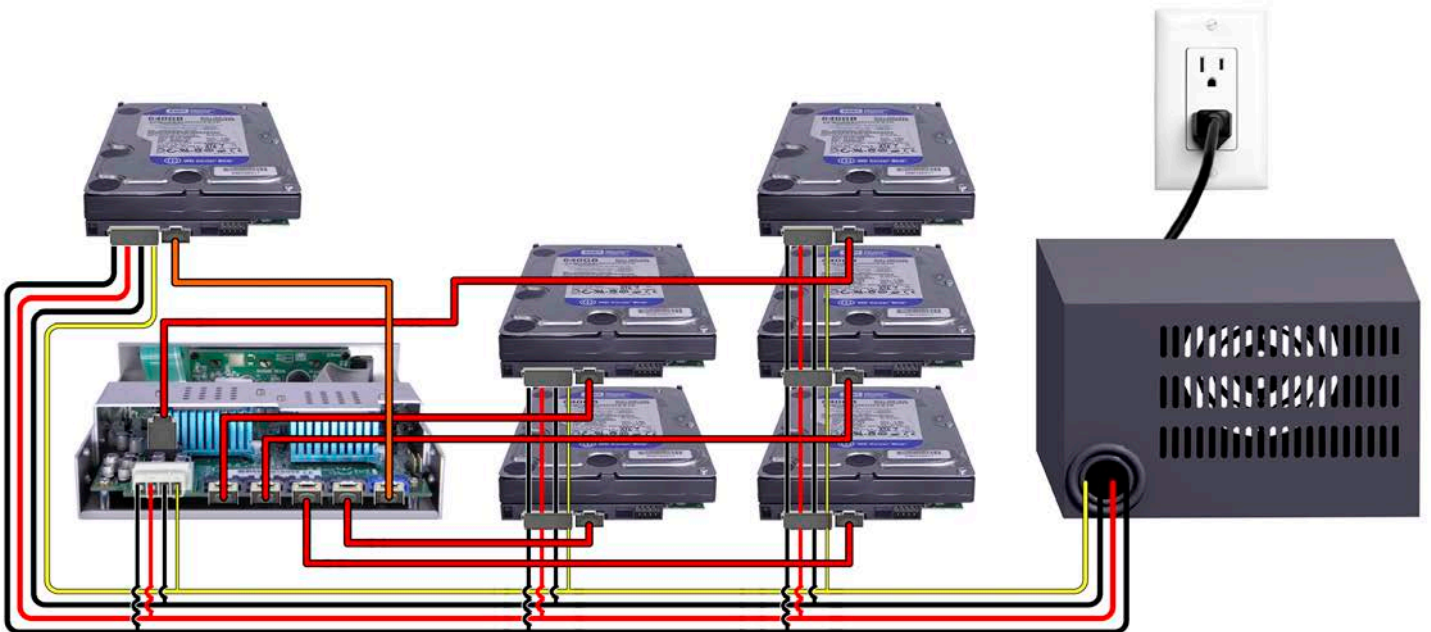

*SATA cable colors are for demonstration purposes only, supplied may consist of all red or all orange cables.

**The displayed HDDs are stacked for demonstration purposes only. Please DO NOT stack HDDs on top of each other as it will cause damages. We highly suggest you use a duplicator tower.

2.5 Install ARS-5509M

The ARS-5509M is shown below:

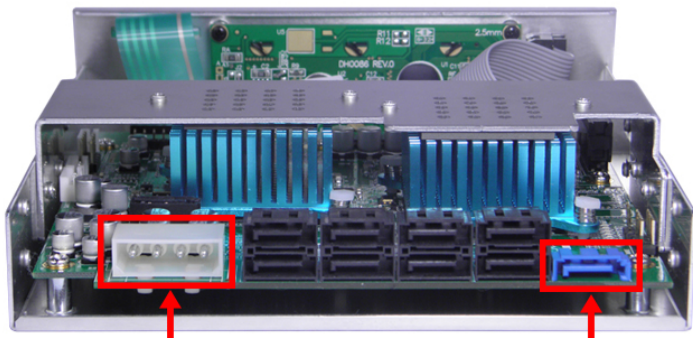

SATA power port (CN24)

Source HDD/SSD (CN12)

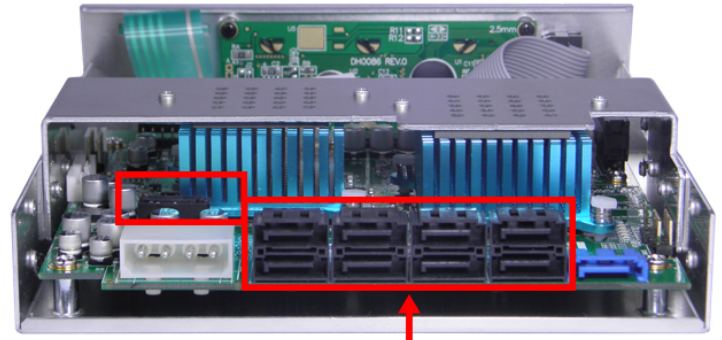

Target HDD/SSD ports

Before Installation

Before connecting the power, please verify that your power supply has enough wattage to operate the controller. The capacity of the target HDDs/SSDs must be greater than or equal to that of the source HDD/SSD. The ARS-5509M includes ten SATA ports: the blue source port and nine black target ports. Please follow the steps below to configure your HDDs/SSDs duplicator setup.

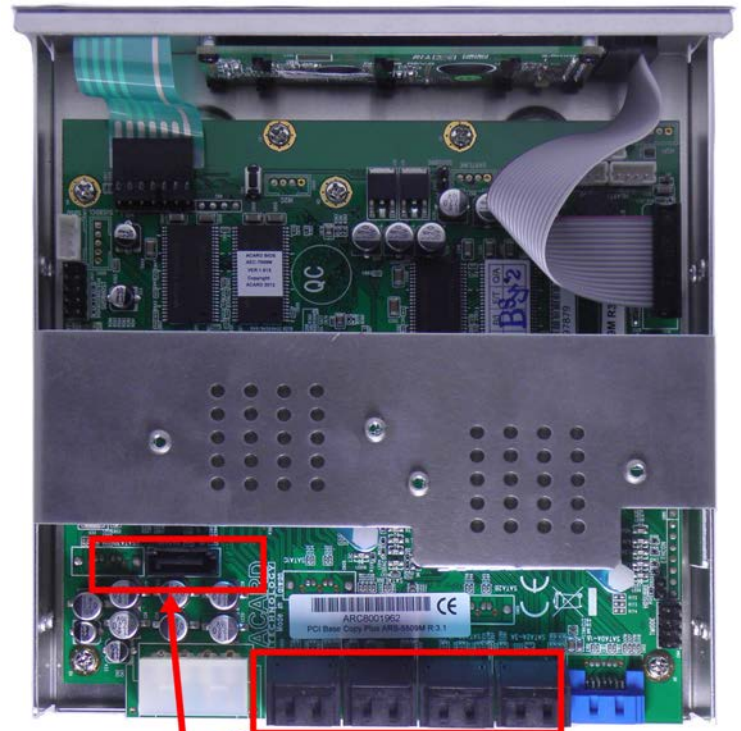

Target HDD/SSD ports

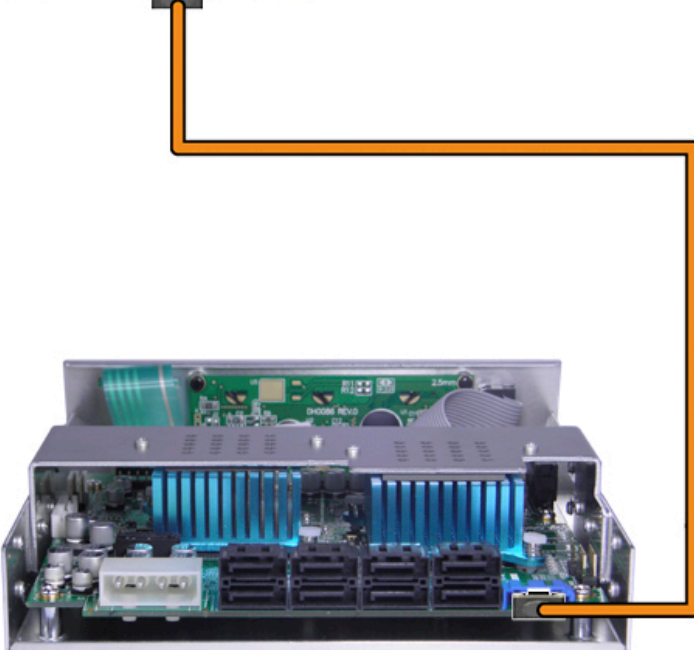

Installation Procedure

1. Connect the source HDD/SSD with the orange SATA cable into the CN12 blue source port on the ARS-5509M. Connect the opposite end of the cable into the source HDD/SSD SATA port:

*SATA cable colors are for demonstration purposes only, supplied may consist of all red or all orange cables.

2. Connect the target HDDs/SSDs with the red SATA cables into the SATA black ports on the ARS-5509M. Connect the opposite end of the cables into the target HDDs/SSDs SATA ports:

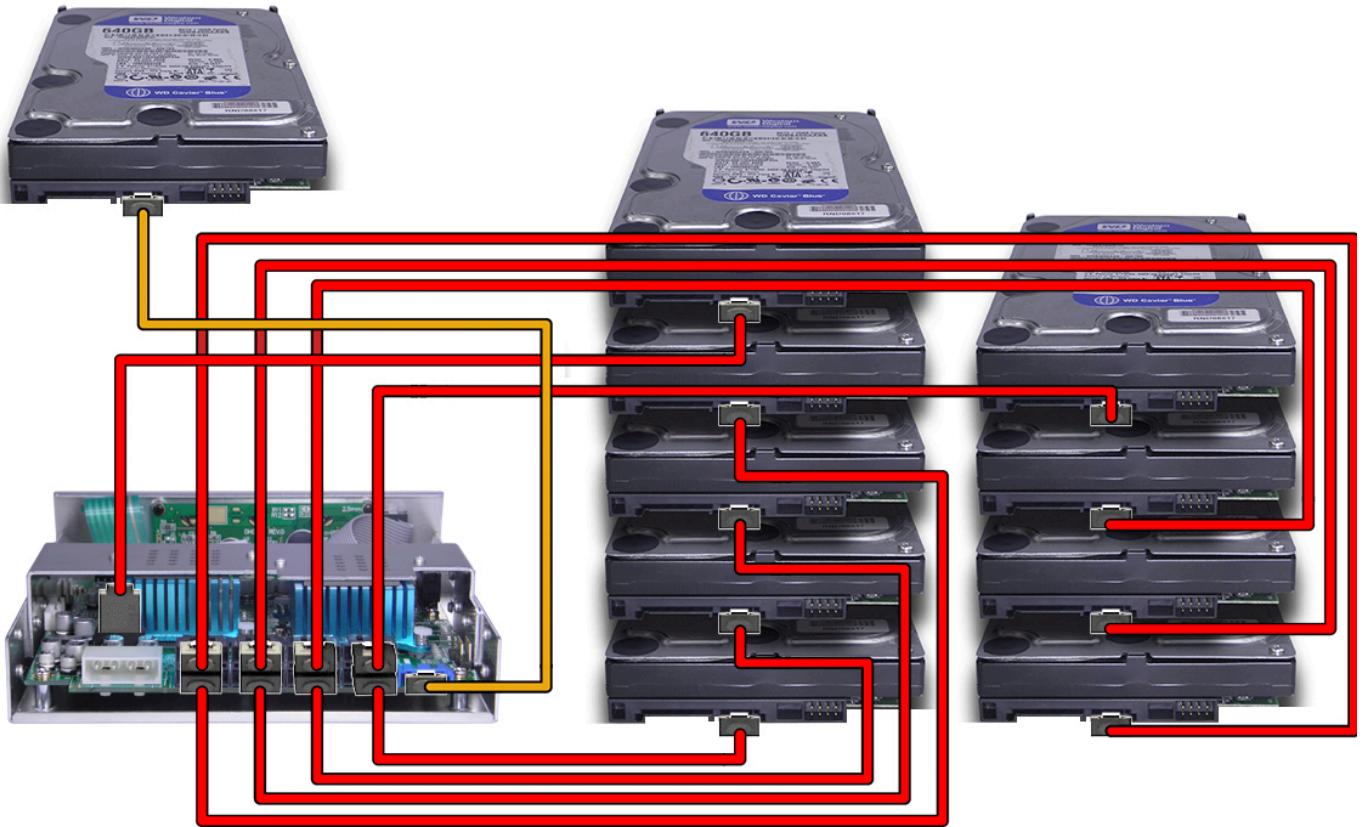

*The displayed HDDs are stacked for demonstration purposes only. Please DO NOT stack HDDs on top of each other as it will cause damages. We highly suggest you use a duplicator tower.

3. Connect the female moxex 4-pin power cable into the male moxex 4-pin power port on the ARS-5509M:

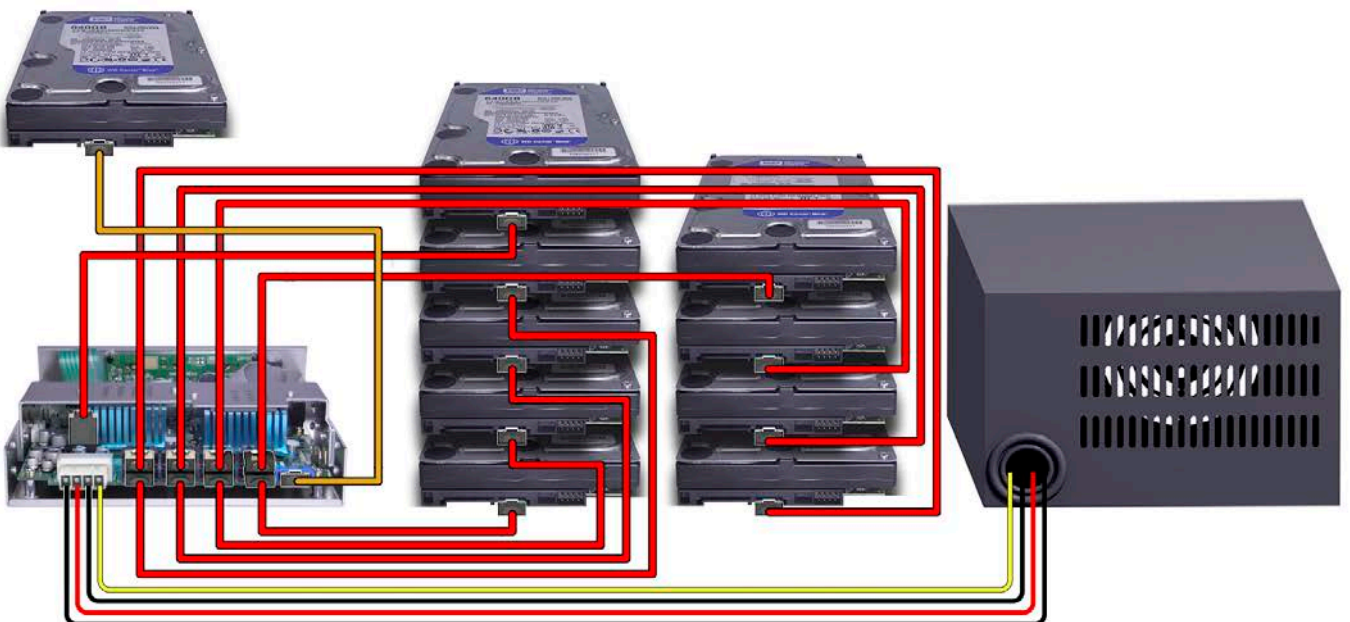

4. Please mate the remaining female SATA power cables into the HDDs/SSDs source and target SATA power ports:

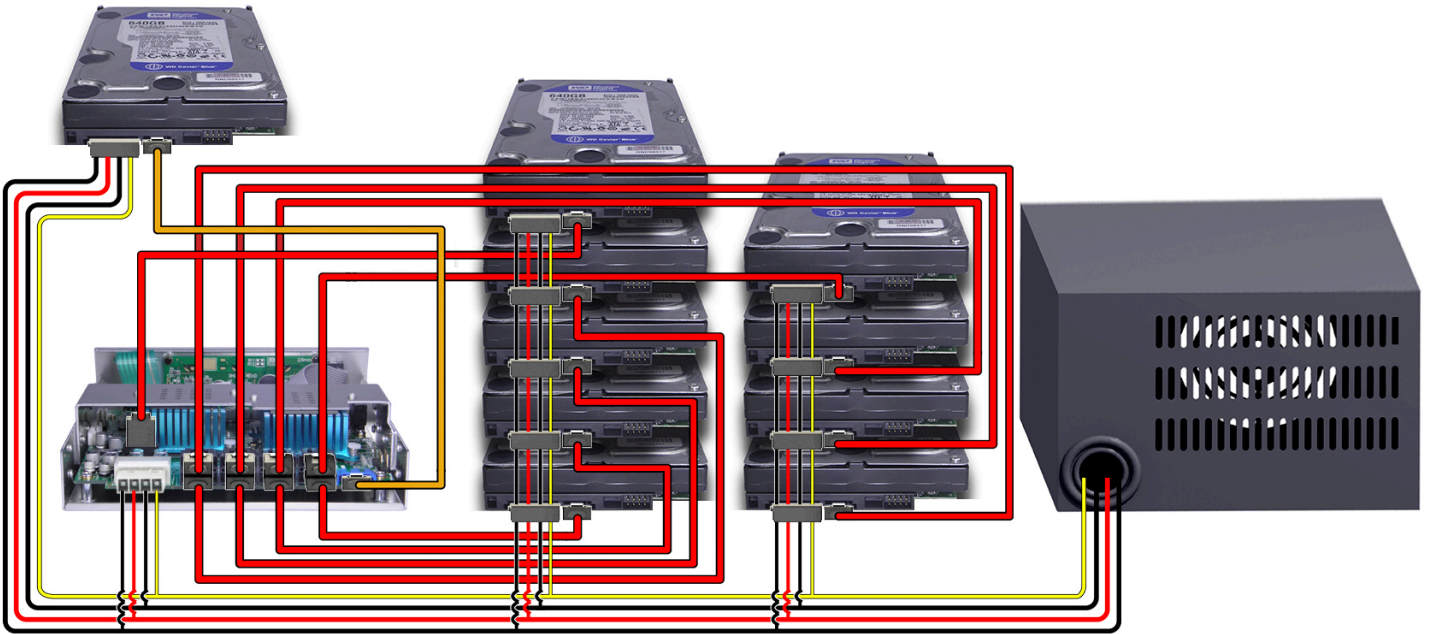

5. The power supply unit can now be turned on (plug into the wall outlet) to boot your copy controller and supply power to your HDDs/SSDs.

Shown below is a ARS-5509M controller with all the SATA and power cables properly configured to the source HDD/SSD, target HDDs/SSDs and power supply unit:

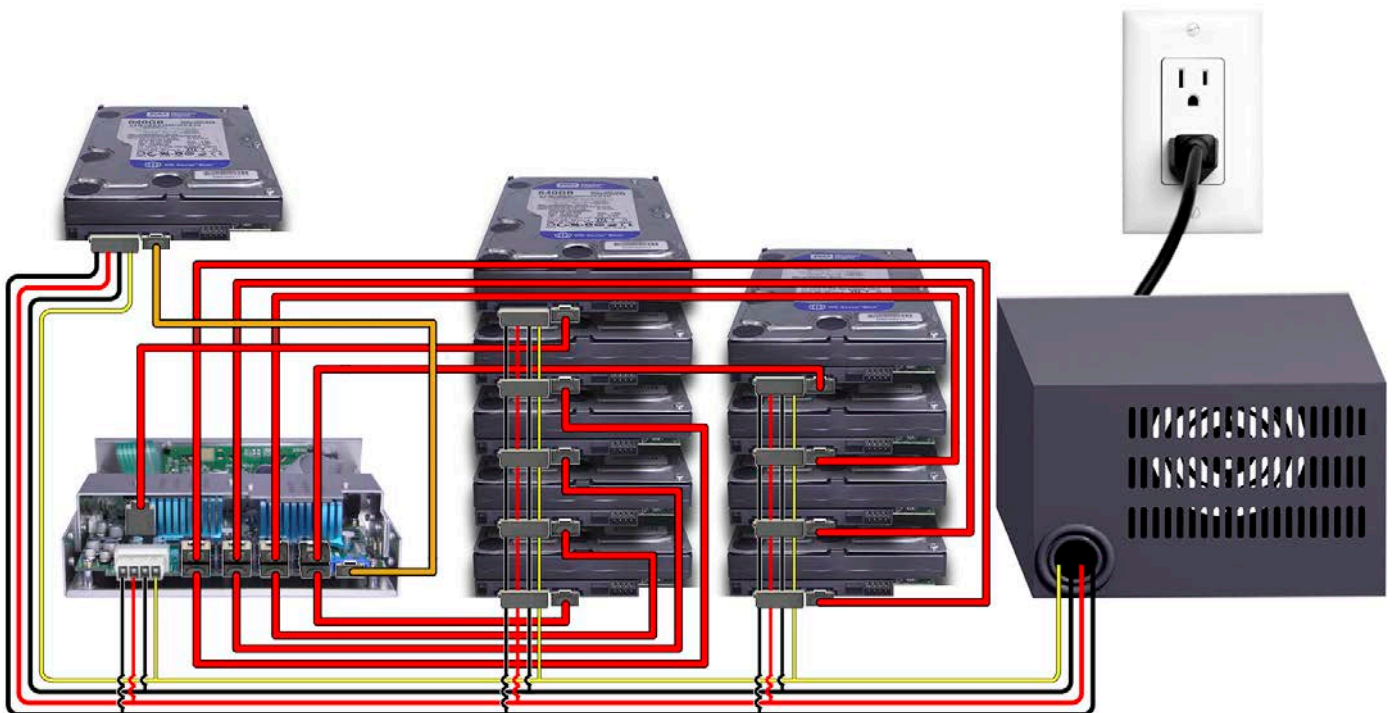

*SATA cable colors are for demonstration purposes only, supplied may consist of all red or all orange cables.

**The displayed HDDs are stacked for demonstration purposes only. Please DO NOT stack HDDs on top of each other as it will cause damages. We highly suggest you use a duplicator tower.

2.6 Install ARS-2061F

The ARS-2061F is shown below:



SATA
power port
(CN24)

Source
HDD/SSD port
(CN12)

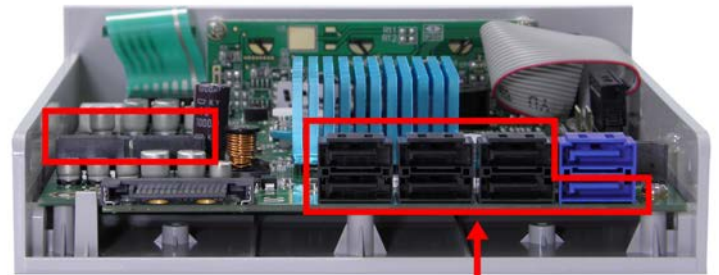

Target
HDD/SSD ports

Before Installation

Before connecting the power, please verify that your power supply has enough wattage to operate the controller. The capacity of the target HDDs/SSDs must be greater than or equal to that of the source HDD/SSD. The ARS-2061F includes twelve SATA ports: the top blue source port, one bottom blue target port, and ten black target ports. Please follow the steps below to configure your HDDs/SSDs duplicator setup.

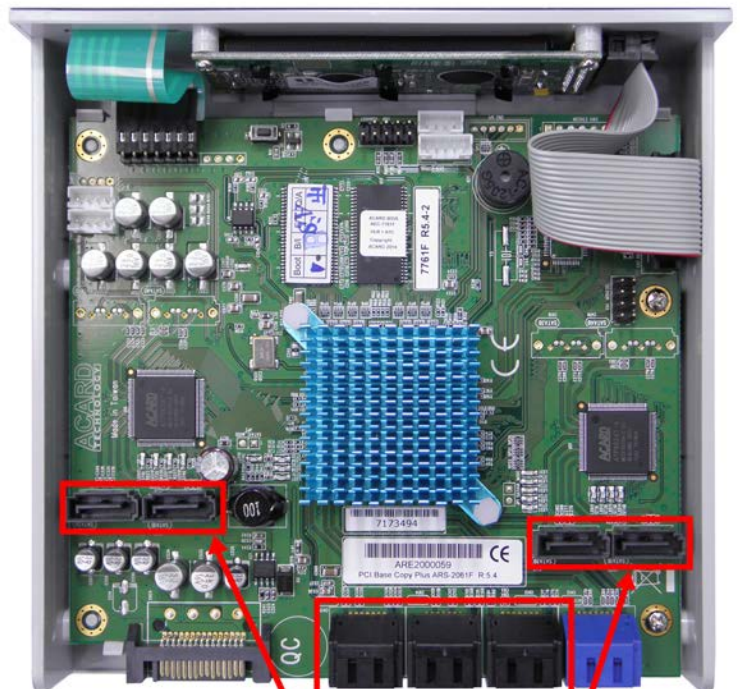

Target HDD/SSD ports

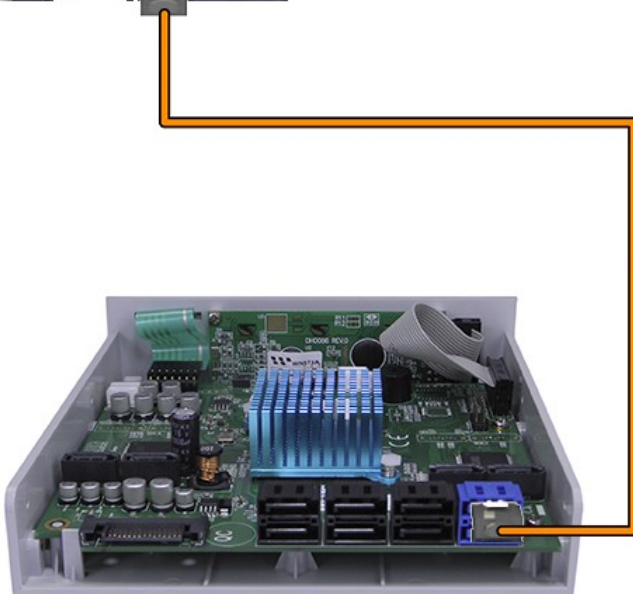

Installation Procedure

1. Connect the source HDD/SSD with the orange SATA cable to the top SATA CN12 blue port on the ARS-2061F. Connect the opposite end of the cable into the source HDD/SSD SATA port:

*SATA cable colors are for demonstration purposes only, supplied may consist of all red or all orange cables.

2. Connect the target HDDs/SSDs with the SATA cable into the SATA black target ports on the ARS-2061F. Connect the opposite end of the cables into the target HDDs/SSDs SATA ports:

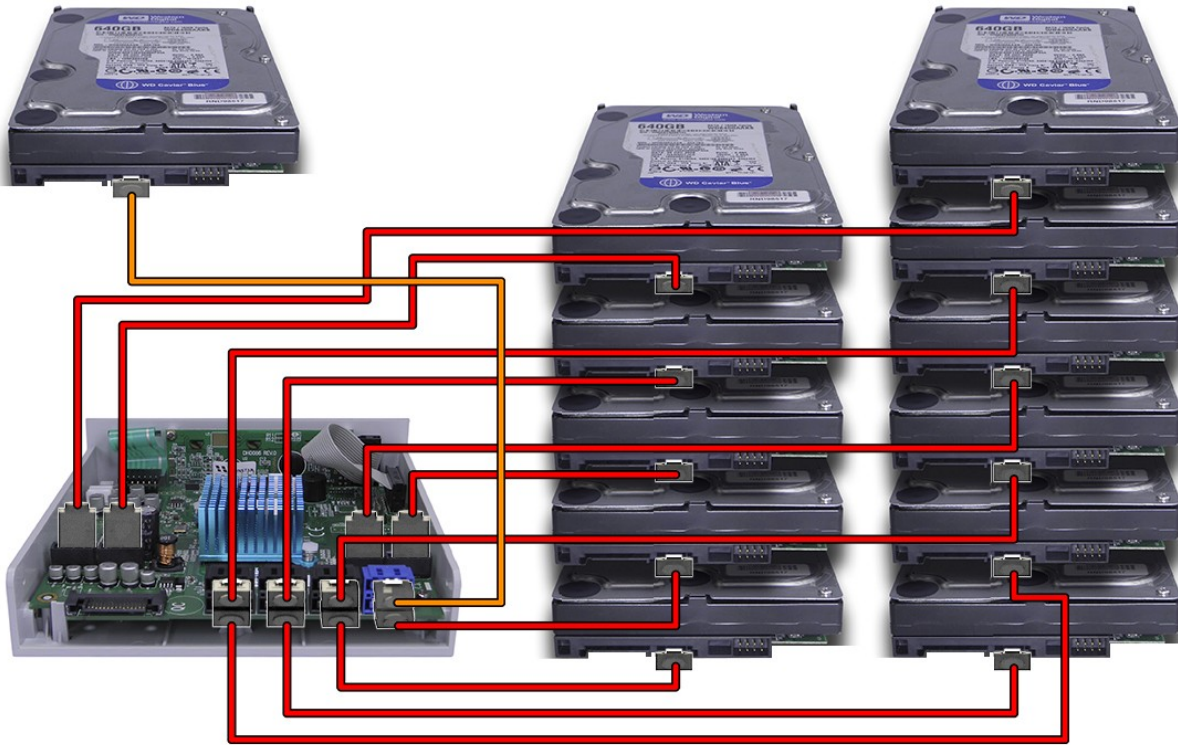

*The displayed HDDs are stacked for demonstration purposes only. Please DO NOT stack HDDs on top of each other as it will cause damages. We highly suggest you use a duplicator tower.

3. Please orient and mate the copy controller L-shape female SATA power cable to its L shape male SATA power connection SATA on the controller's PCB:

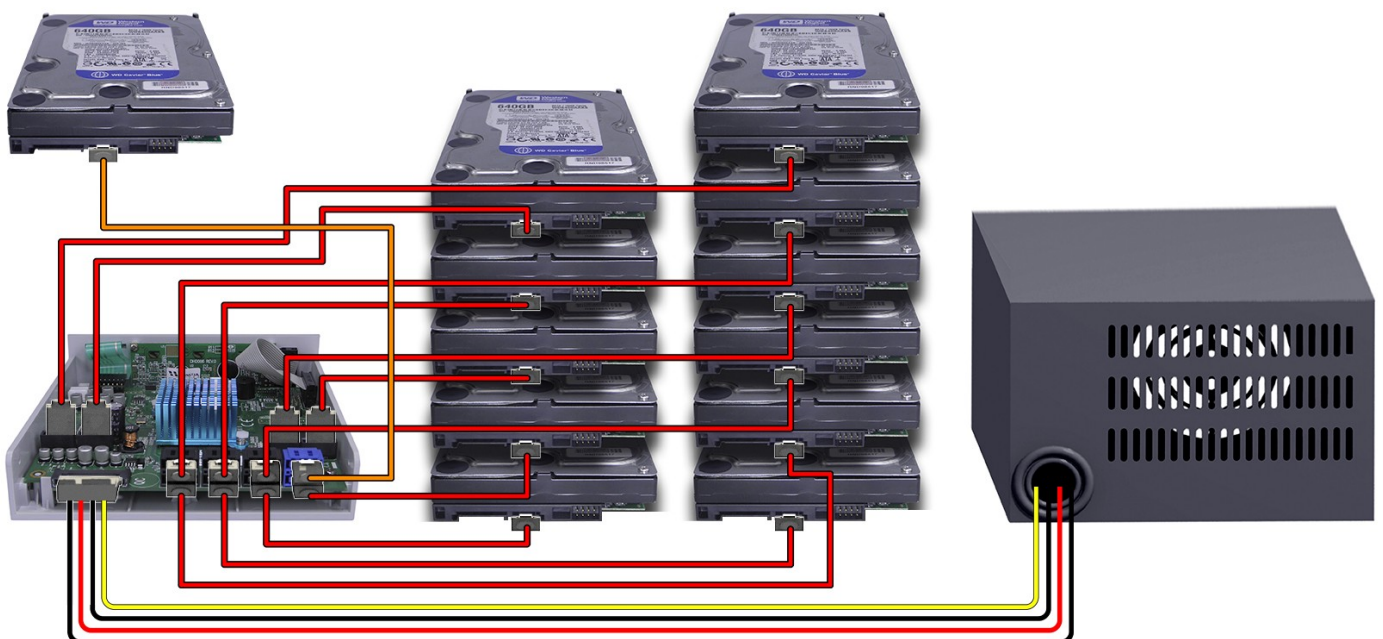

4. Please mate the remaining female SATA power cables into the HDDs/SSDs source and target male SATA power ports:

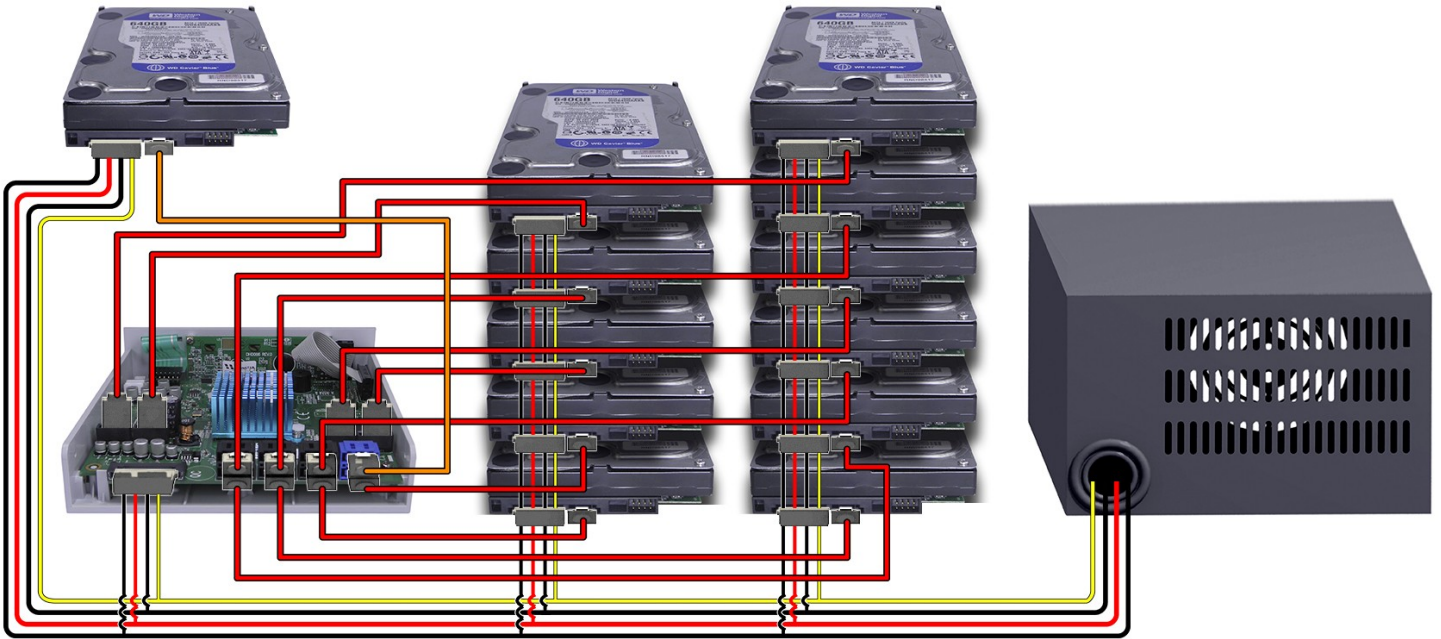

5. The power supply unit can now be turned on (plug into the wall outlet) to boot your copy controller and supply power to your HDDs/SSDs.

Shown below is a ARS-2061F controller with all the SATA and power cables properly configured to the source HDD/SSD, target HDDs/SSDs, and power supply unit:

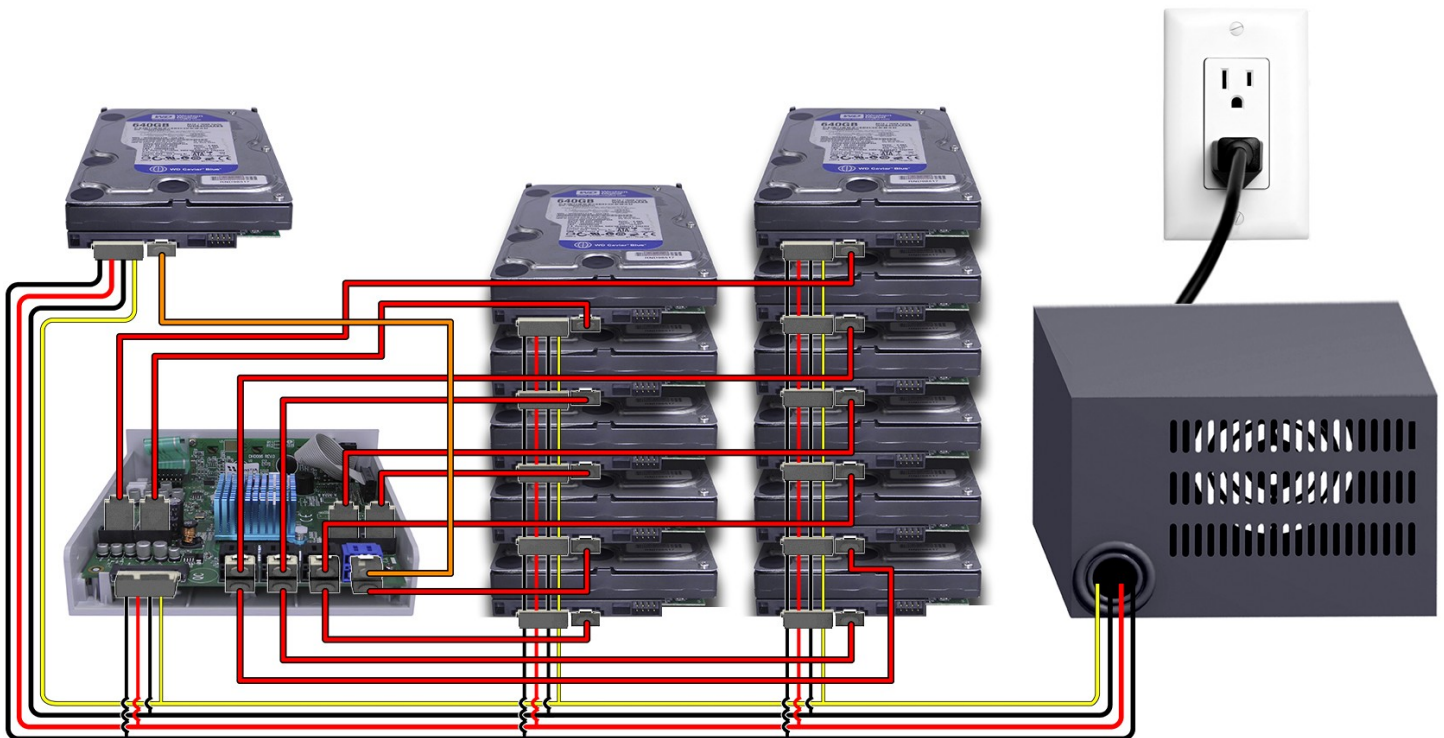

*SATA cable colors are for demonstration purposes only, supplied may consist of all red or all orange cables.

**The displayed HDDs are stacked for demonstration purposes only. Please DO NOT stack HDDs on top of each other as it will cause damages. We highly suggest you use a duplicator tower.

Chapter 3 Basic Instructions

3.1 Buttons and LCD

There are four buttons and an LCD on the panel of SATA HDD Duplicator Controller.

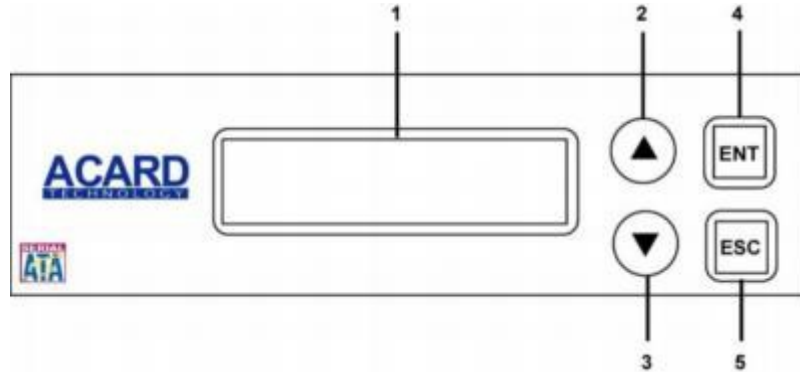

1. It shows a function or a message.
2. It's used to scroll up function menus.
3. It's used to scroll down function menus.
4. It's used to execute a function.
5. It's used to cancel a function.

3.2 LCD Configuration Chart

Here we take ARS-5503H to demonstrate:

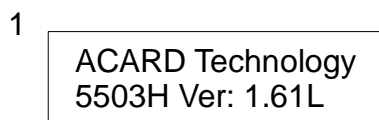

Figure 1 shows the firmware version of ARS-5503H.

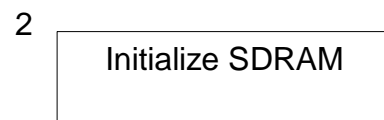

Figure 2 shows Initialize SDRAM's status.

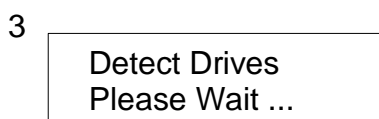

Figure 3 shows Detect Drives's status.

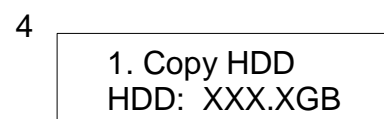
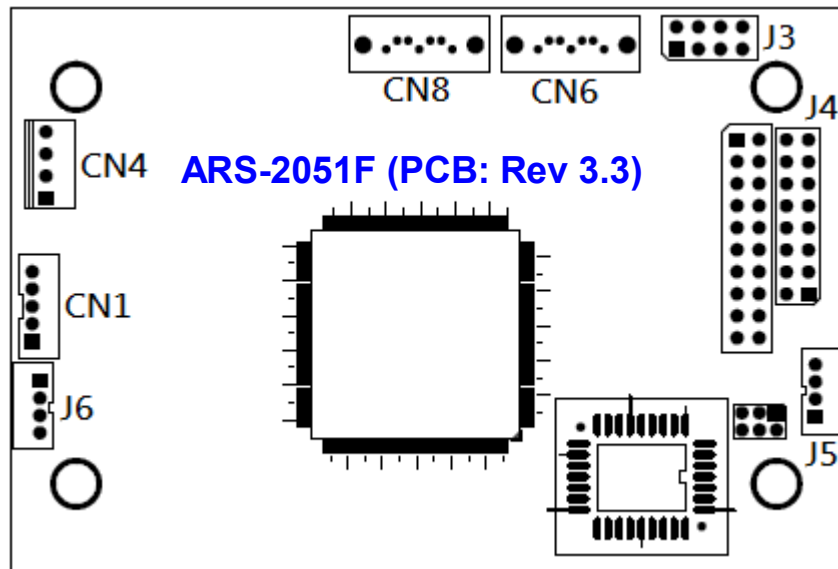

Figure 4 shows the first function Copy HDD. There are 8 functions. You can press ▼ to see other functions.

Chapter 4 Board Layout

The board layout of ARS-2051F is shown as follows:



PS: CN8 is USB port for firmware update.

The board layout of ARS-5503M/5503H is shown as follows:

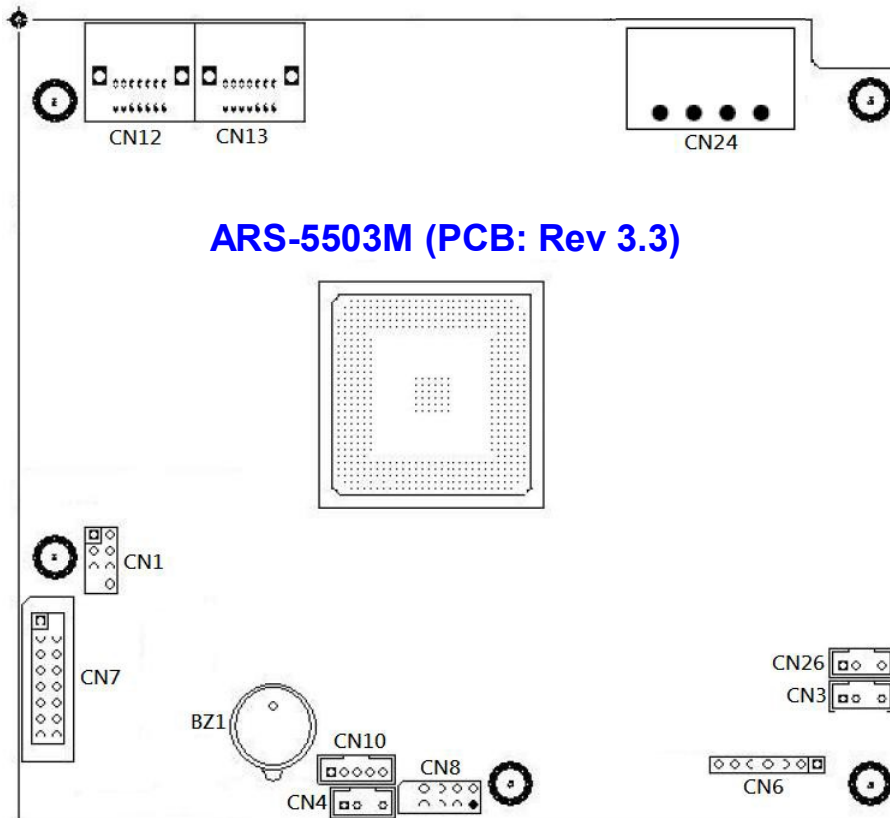

PS: CN8 is USB port for firmware update.

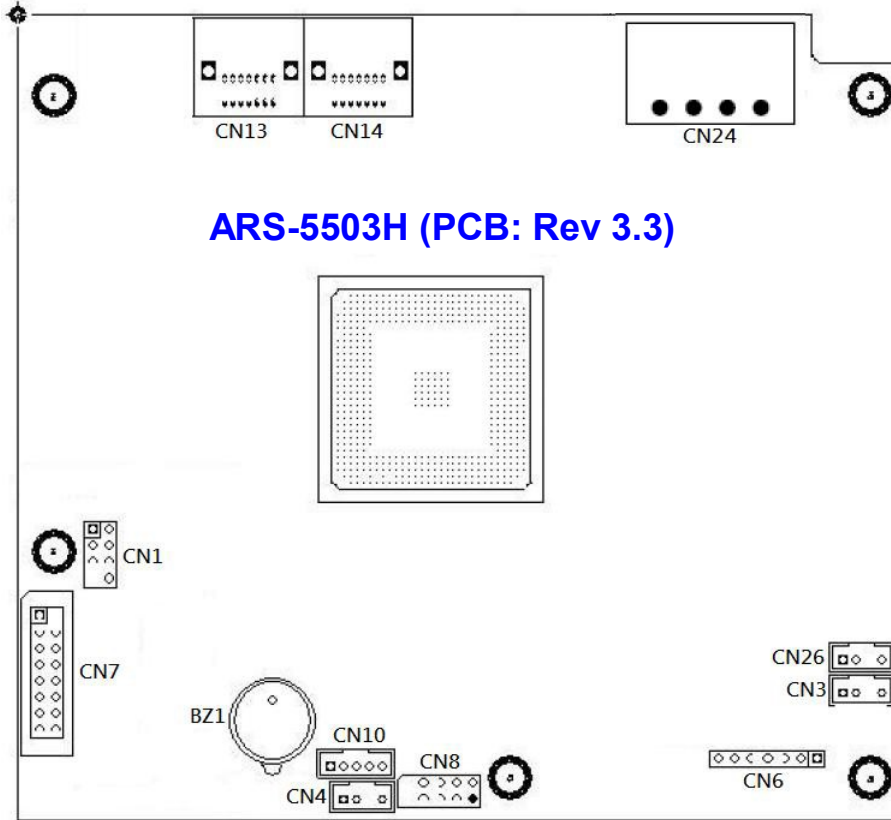

PS: CN8 is USB port for firmware update.

The board layout of ARS-2055PF/5505E/5505M/5505H is shown as follows:

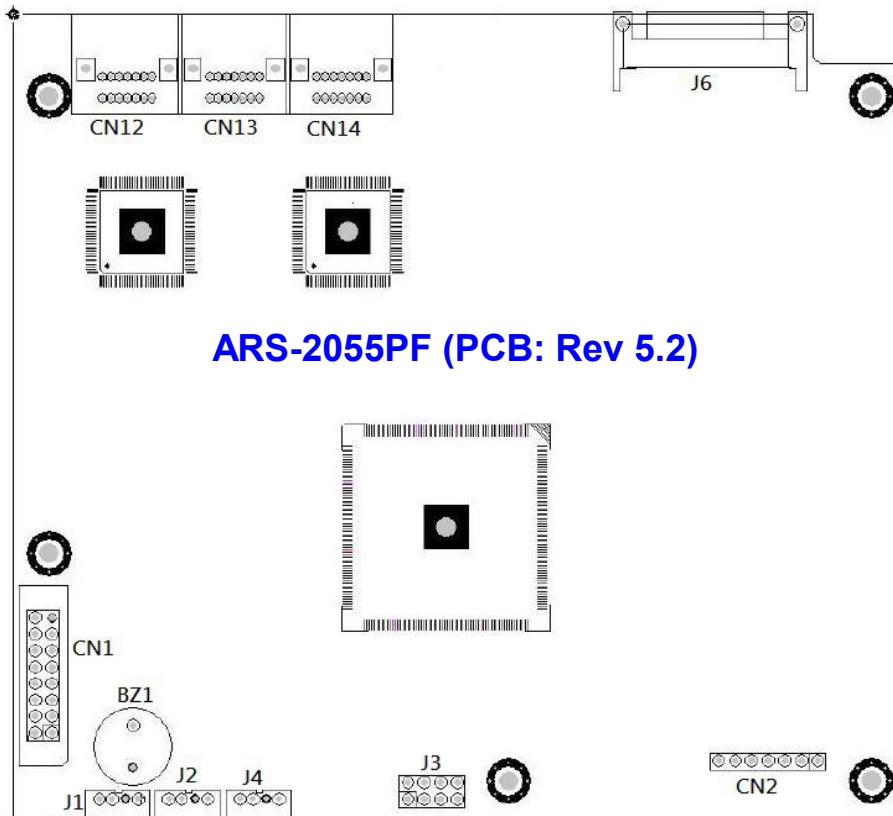

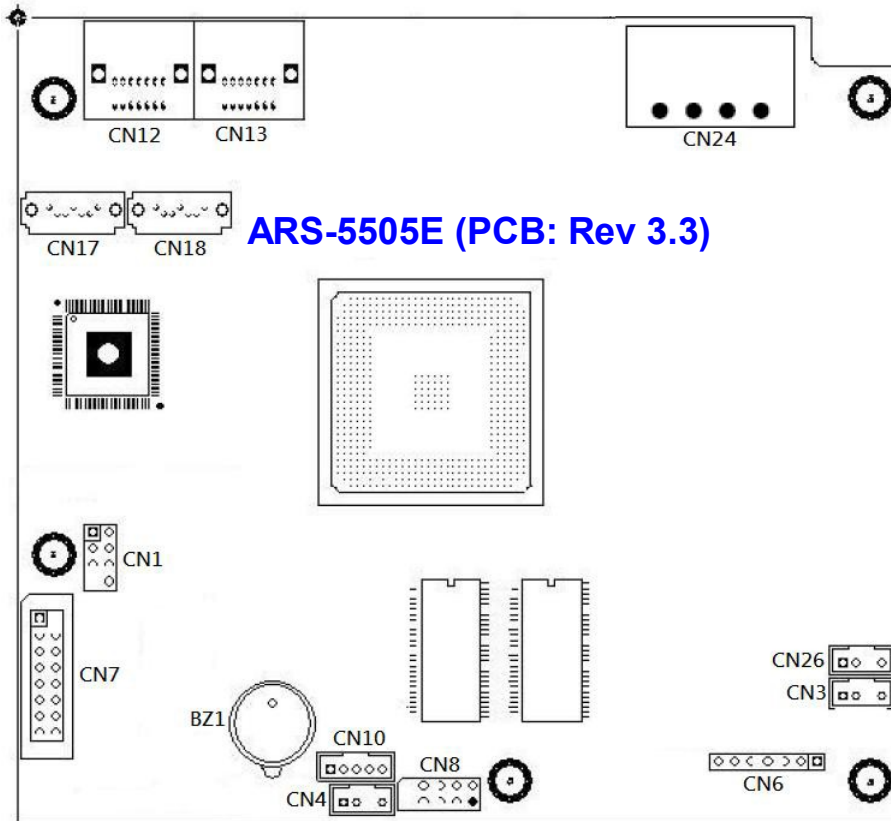

PS: CN8 is USB port for firmware update.

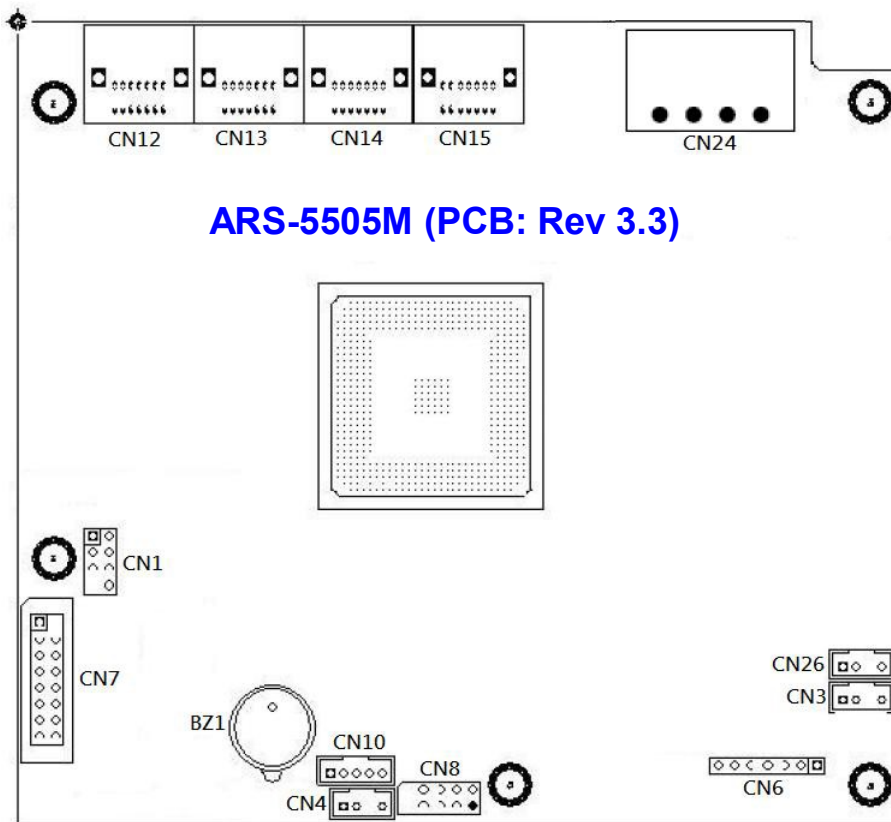

PS: CN8 is USB port for firmware update.

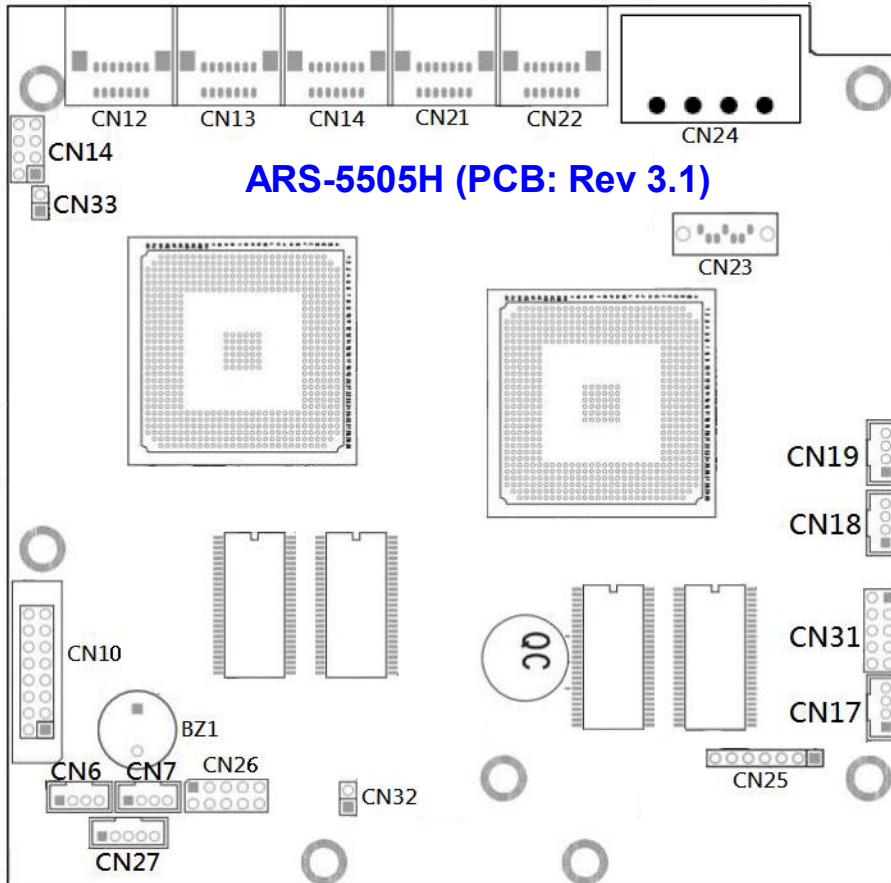

PS: CN26 is USB port for firmware update.

The board layout of ARS-5509M is shown as follows:

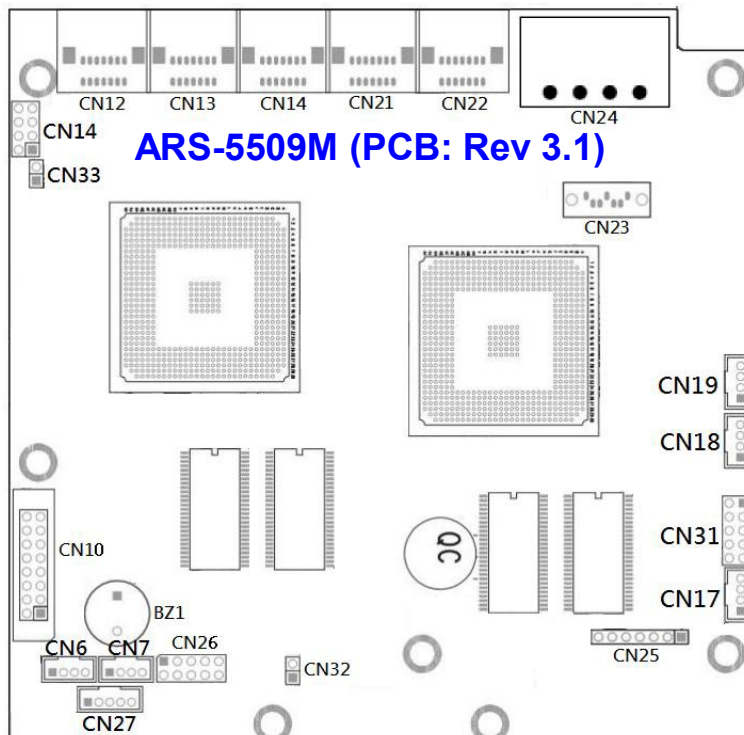

PS: CN26 is USB port for firmware update.

The board layout of ARS-2061F is shown as follows:

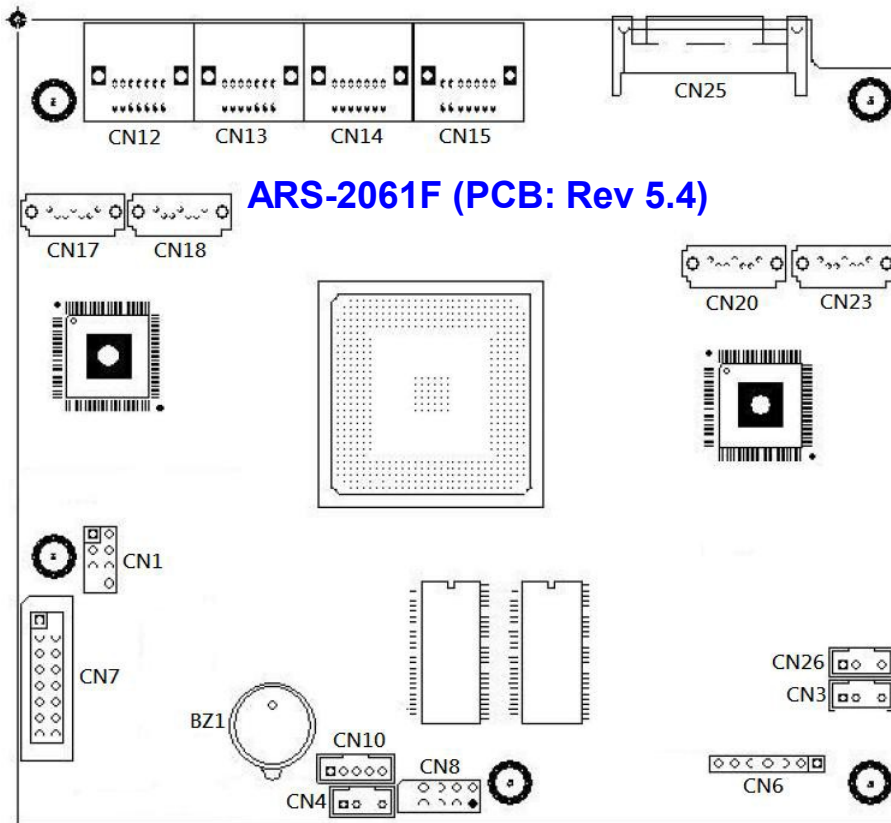

PS: CN8 is USB port for firmware update.

Chapter 5 Functions

The copy controller has 9 functions in total, with the 10th (Adv Setup) being a hidden system function that only appears when the ESC key is pressed for 2 seconds until there is a beep. These are shown below.

Model ARS-2051F is as below:

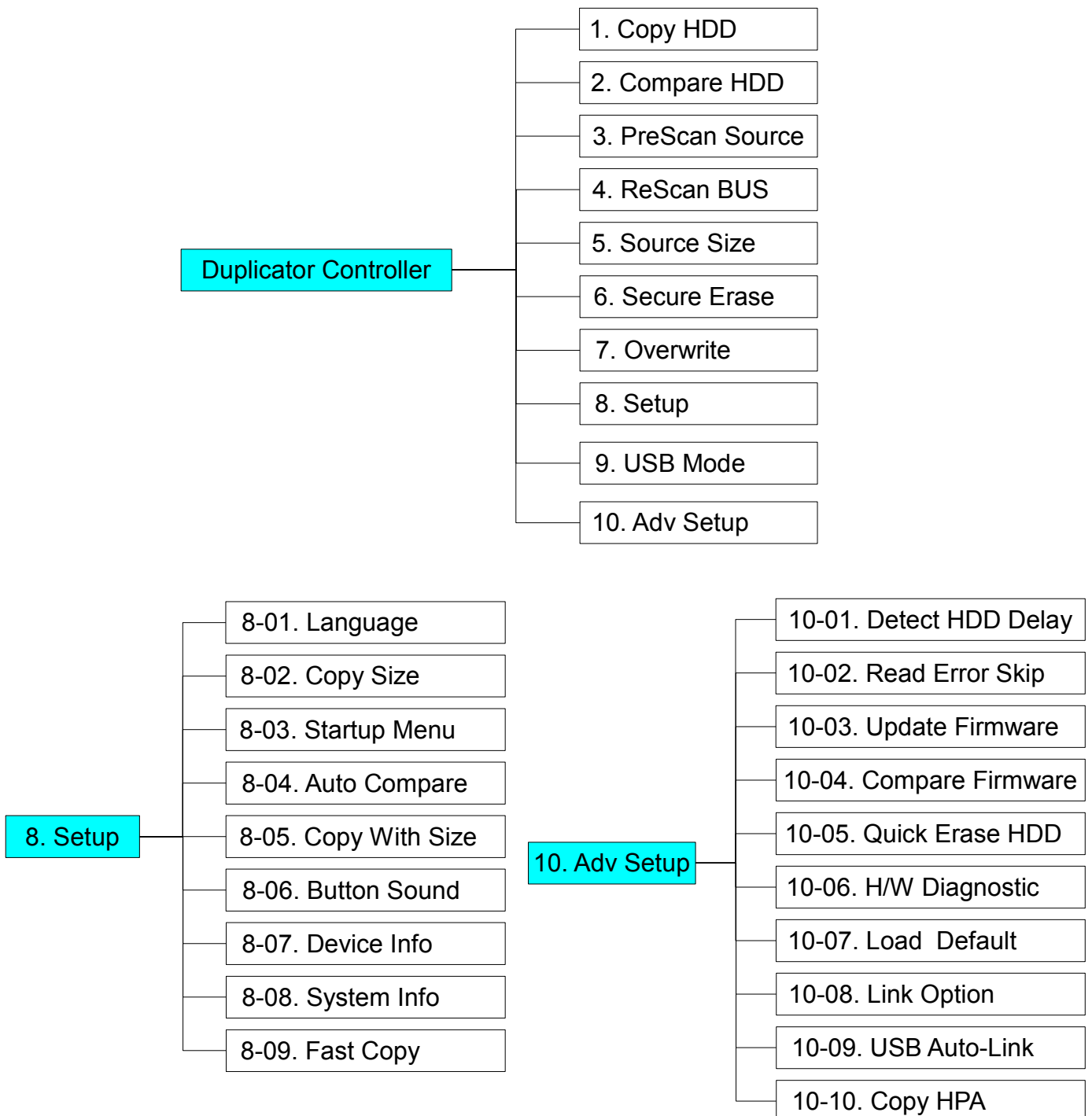

The copy controller has 11 functions in total, with the 12th (Adv Setup) being a hidden system function that only appears when the ESC key is pressed for 2 seconds until there is a beep. These are shown below.

ARS-5503M/5503H, ARS-2055PF, ARS-5505E/5505M/5505H, ARS-5509M, ARS-2061F are as below:

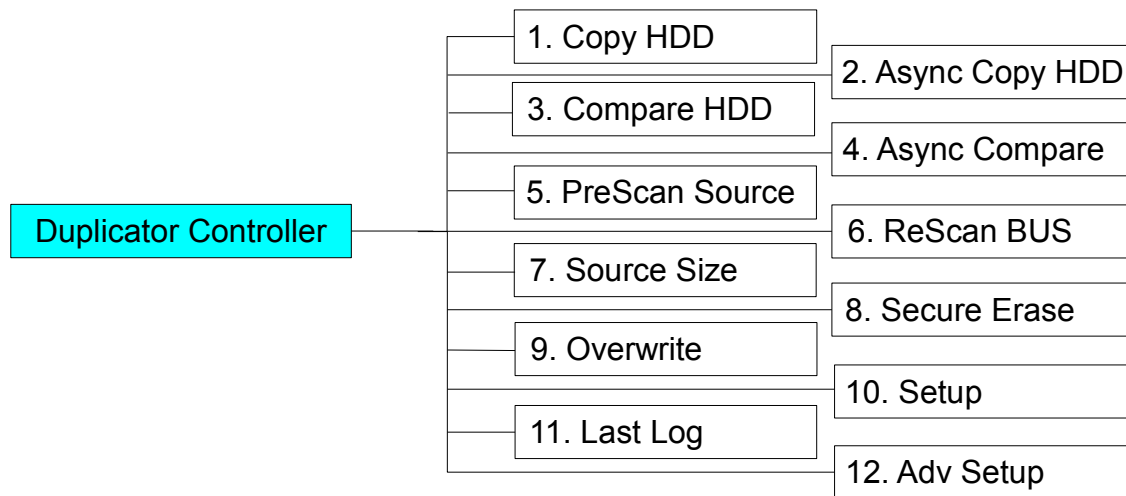

In Function#10 there are 14 sub-functions

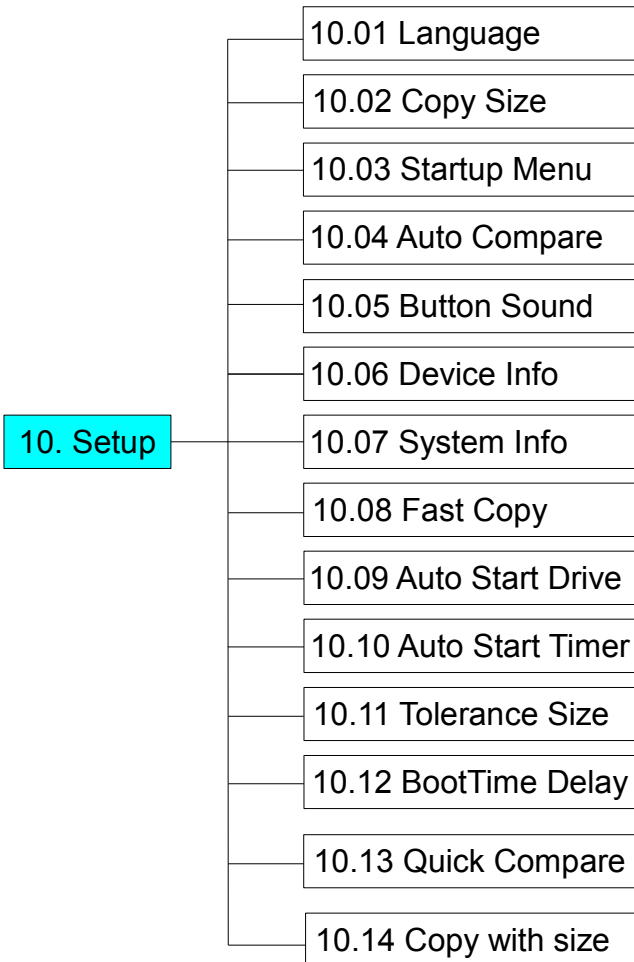

In Function#12 there are 9 sub-functions

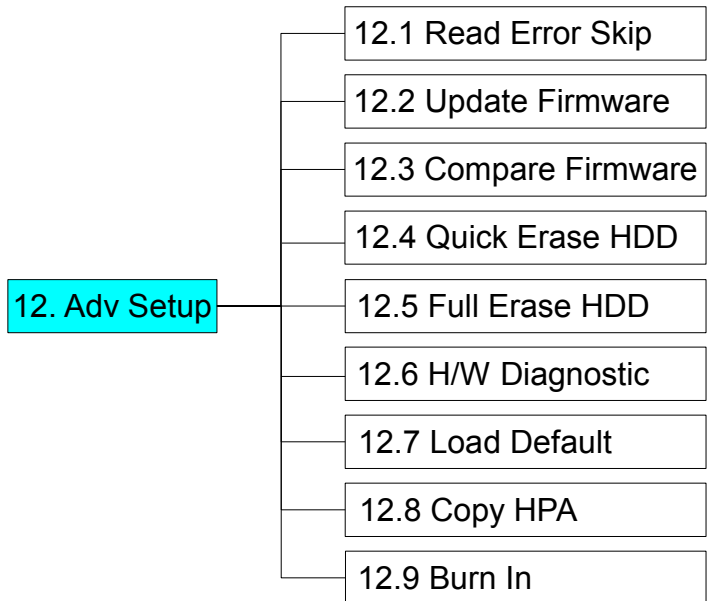

Here we take ARS-5503H to demonstrate.

5.1 Copy HDD

Copy HDD copies data directly from the source hard disk to the target hard disk. Please make sure that the capacity of the target hard disk is equal or larger than the source hard disk.

Choose option 1 from the menu:

```
1. Copy HDD
HDD:4  232.9GB
```

Press **ENT** to begin copy. The system will auto-detect the hard disks and show the following copying info on the LCD:

```
Copy-36MB/s  0%
232.9GB  00:00:00
```

The LCD will show the following info during the copying process: elapsed time, completed percentage. The copy speed, capacity and time will vary depending on the source hard disk. Once the copying process is complete the LCD will display the following results:

```
Copy HDD
OK: 3    Fail: 0
```

5.2 Async Copy HDD (ARS-2051F not support) This option allows when the replication process can increase the extra hard disk devices. Choose option 2 from the menu:

```
2. Async Copy HDD
HDD:4  232.9GB
```

Press **ENT**. Before the start of the reproduction, if the ARS-5503H to detect the 3rd hard drive capacity is less than source, then the LCD will show the corresponding channel number:

```
3
Space Not Enough
```

And then automatically copies. The LCD will display the following info:

```
Acpy-36MB/s  0%
232.9GB  00:00:00
```

If the replication process to continue to add additional hard disk device, LCD will only show the last completed percentage.

Once the copying process is complete the LCD will display the following results:

```
Async Copy HDD
OK: 3    Fail: 0
```

5.3 Compare HDD

Compare HDD is used to see if the data on a source hard disk is identical to the target hard disk after the Copy HDD operation.

Choose option 3 from the menu:

```
3. Compare HDD
HDD: 4   232.9GB
```

Press **ENT** to begin the comparison. The LCD will display the following info:

```
Comp-23MB/s  0%
232.9GB  00:00:00
```

Once the comparison is complete the LCD will display the following info as well as the amount of data on the source hard disk:

```
Compare  OK:3
Fail: 0   Diff: 0
```

Attention:

After performing a copy and/or compare, a “Fail” or “Diff” hard drive reading will appear:

```
Compare  OK:10
Fail: 1   Diff: 0
```

In order to identify which hard drive(s) has failed, press the arrow up or arrow down keys on the controller panel membrane until the hard drive channel (CH) displays “Fail” or “Diff” on the various target channels (Target CH).

A hard drive with no issues will display the following: “Identical”:

```
1 Target  CH: 1
Identical
```

If the following hard drive channel indicates “Fail”, please take the proper steps to test/replace the failed hard drive:

```
10 Target  CH: 10
Fail!
```

Attention: This is Function 2 of ARS-2051F.

5.4 Async Compare (ARS-2051F not support)

This option allows the comparison process can increase the extra hard disk devices.

Choose option 4 from the menu:

```
4. Async Compare
HDD: 4   232.9GB
```

Press **ENT** to begin the async comparison. The LCD will display the following info:

```
ACmp-23MB/s  0%
232.9GB  00:00:00
```

If the comparison process to continue to add additional hard disk device, LCD will only show the last completed percentage.

Once the copying process is complete the LCD will display the following results:

```
Compare  OK:3
Fail: 0   Diff: 0
```

5.5 PreScan Source

PreScan Source is used to check if the source hard disk can be accessed properly. It also tests the read speed.

Choose option 5 from the menu:

```
5. PreScan Source
HDD : 4  232.9GB
```

Press **ENT** to begin scan. The LCD will display the following info:

```
Scan-90MB/s  1%
230.6GB  00:00:27
```

Once the scan is complete, the LCD will display the corresponding results:

```
PreScan OK!
```

Attention: This is Function 3 of ARS-2051F.

5.6 ReScan BUS

ReScan BUS is used to re-scan all devices on the duplicator.

Choose option 6 from the menu:

```
6. ReScan BUS
```

Press **ENT** to re-scan hardware. The LCD will display the following info:

```
Re-Scan BUS NOW?
Yes
```

When the scan is complete the LCD will display the following info:

```
Bus re- scan OK!
```

Attention: This is Function 4 of ARS-2051F.

5.7 Source Size

Source Size is used to show the capacity message of the source hard disk.

Choose option 7 from the menu:

```
7. Source Size
```

Press **ENT** and the LCD will show the following info:

```
HDD:Hitachi
Size:232.9GB
```

Then press **ENT** and the LCD will show the data's size info:

```
HDD:Hitachi
Data:200.9GB
```

Attention: This is Function 5 of ARS-2051F.

5.8 Secure Erase

Secure Erase is used to do data-erase operations to the hard drive by command order from HDD itself. This function will erase all HDD with 00 character in the tray (included Source tray), please be careful when use it.

Choose option 8 from the menu:

8. Secure Erase

Press **ENT** to access option. By default it is set to No. Use the Up and Down arrow keys to choose Yes.

Wipe all data.
Continue? No

Press **ENT** and the LCD will show the following info:

In Process
Elapsed 01:00

Attention: This is Function 6 of ARS-2051F.

5.9 Overwrite

Overwrite is used to do data-erase operations to the hard drive by command order from controller itself. There are 3 sub-options: One pass (all 00 character), 3 pass (00, ff, random character) and 7 pass 5220.22-M (f6,00, ff, random, 00,ff,random character). This function will erase all HDD in the tray (included Source tray), please be careful when use it.

Choose option 9 from the menu:

9. Overwrite

Press **ENT** to access option. By default it is One pass Use the Up and Down arrow keys to choose other options:

9-01. Overwrite
One pass

Press **ENT** to access option. By default it is set to No. Use the Up and Down arrow keys to choose Yes.

Wipe all data.
Continue? No

Press **ENT** and the LCD will show the following info:

In Process
Elapsed 01:00

Attention: This is Function 7 of ARS-2051F.

5.10 Setup

Setup allows various system settings to be changed. There are 13 sub-options: Language, Copy Size, Startup Menu, Auto Compare, Button Sound, Device Info, System Info, Fast Copy, Auto Start Drive, Auto Start Timer, Tolerance Size, BootTime Delay, Quick Compare and Copy with size.

Choose option 8 from the menu:

10. Setup

Attention: This is Function 8 of ARS-2051F.

5.10.1 Language

This option is used to select the system's language support. By default this is set to English. Press **ENT** to change the Language settings.

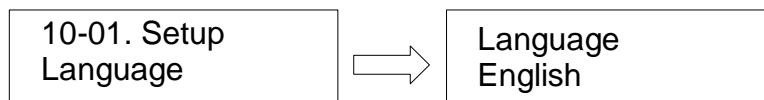

5.10.2 Copy Size

This option is used to specify the size of the source hard disk for simplifying further copying operations.

10-02. Setup
Copy Size

Press **ENT** and the LCD will display a detailed list of options as shown below:

Copy Size
100%~1% (*MB)

Use the Up and Down arrow keys to choose different copy sizes. The system will offer their corresponding percentages so the user can specify the amount to copy from the source hard disk. Press **ENT** to confirm and save the changes.

5.10.3 Startup Menu

This option allows you to set an option other than "Setup" to be displayed as the first available option on the menu every time you start the system.

10-03. Setup
Startup Menu

Press **ENT** then use the Up and Down arrow keys to choose other options. By default the first menu option is Copy HDD:

Startup Menu
1. Copy HDD

5.10.4 Auto Compare

This option automatically compares the source hard disk with the target hard disk after a copy operation is completed.

10-04. Setup
Auto Compare

Press **ENT** to access option. By default it is set to Off. Use the Up and Down arrow keys to choose On.

Auto Compare
Off

5.10.5 Button Sound

This option is used to control the sound of a button when you press it.

10-05. Setup
Button Sound

Press **ENT** and the LCD will display the following info. Use the Up and Down arrow keys to choose whether button sound is on or off:

Button Sound
On

Attention: This is Function 8-06. of ARS-2051F.

5.10.6 Device Info

This option is used to display the details of all hard disks connected to the copy controller.

10-06. Setup
Device Info

Press **ENT** and the LCD will display each hard disk' information in order as shown below:

0 Source CH: 0
Hitachi 232.9GB

Attention: This is Function 8-07. of ARS-2051F.

5.10.7 System Info

This option displays system information:

10-07. Setup
System Info

Attention: This is Function 8-08. of ARS-2051F.

5.10.8 Fast Copy

This option displays Fast Copy:

10-08. Setup
Fast Copy

Press **ENT** and the LCD will display the following info. Use the Up and Down arrow keys to choose whether fast copy is on or off. (This function currently only effective in FAT, FAT32, NTFS, HFS+, Ext2 and Ext3 partitions.)

Fast Copy
On

Attention: This is Function 8-09. of ARS-2051F, and it does not support HFS+.

5.10.9 Auto Start Drive

This option is used to display to copy automatically once you insert HDD on target port:

```
10-09. Setup
Auto Start Drive
```

Press **ENT** to enter the following figure. The default is Off. Use the Up and Down arrow keys to choose 1-11:

```
Auto Start Drive
Off
```

5.10.10 Auto Start Timer

This option is used to display to copy automatically once you insert HDD on target port.

```
10-10. Setup
Auto Start Timer
```

Press **ENT** to enter the following figure. The default is Off. Use the Up and Down arrow keys to choose 5 Sec-50 Sec:

```
Auto Start Timer
Off
```

5.10.11 Tolerance Size

This option is used to do to ensure that when the target is smaller than the source can not be performed when the copy:

```
10-11. Setup
Tolerance Size
```

Press **ENT** to enter the following figure. The default is Off. Use the Up and Down arrow keys to choose 1MB~100MB of source:

```
Tolerance Size
1MB
```

5.10.12 BootTime Delay

This option is used to to set boot delay time.

```
10-12. Setup
BootTime Delay
```

Press **ENT** to enter the following figure. The default is 5 sec. Use the Up and Down arrow keys to choose 0~99 sec:

```
BootTime Delay
5 sec
```

5.10.13 Quick Compare

This option is used to set the size of each comparison unit:

10-13. Setup
Quick Compare

Press **ENT** to enter the following figure. The default is Off. Use the Up and Down arrow keys to choose 1 Byte/1K/10K/100K/1MB/10MB/100 Mbytes. (In order to improve the accuracy of pure data can maintain the default settings.)

Quick Compare
Off

5.10.14 Copy with size

This option is used to set the source hard disk with the target hard disk the same capacity after a copy operation:

10-14. Setup
Copy with size

Press **ENT** to enter the following figure. The default is Off. Use the Up and Down arrow keys to choose On:

Copy with Size
Off

Attention: This is Function 8-05. of ARS-2051F.

5.11 Last Log (ARS-2051F/2055PF/2061F not support)

This function is used to view related messages after the copying function has completed.

While the copying function is executing or when it has ended, the LCD will display the following screen, "this is currently recording the copying results":

Recording Log
Please Wait.....

You can press ▲ ▼ to select Function#11.

11. Last Log

When you enter Function#10, you can see information about the last copying result:

Source HDD #0
Identical

After you have finished viewing the information, you may press any button to exit that screen.

D1: OK D2: OK
D3: OK

Attention:

After performing a copy and/or compare, a “Fail” or “Diff” hard drive reading will appear:

10 Target CH:10
Fail

In order to identify which hard drive(s) has failed, press the arrow up or arrow down keys on the controller panel membrane until the hard drive channel (CH) displays “Fail” or “Diff” on the various target channels (Target CH).

A hard drive with no issues will display the following: “Identical”:

1 Target CH: 1
Identical

If the following hard drive channel indicates “Fail”, please take the proper steps to test/replace the failed hard drive.

Compare OK:10
Fail: 1 Diff: 0

5.12 Adv Setup

Adv Setup offers expert users access to more advanced system settings. It has 9 sub-options: Read Error Skip, Update Firmware, Compare Firmware, Quick Erase HDD, Full Erase HDD, H/W Diagnostic, Load Default, Copy HPA and Burn In. To access this option, hold down the **ESC** key for two seconds until it appears:

12. Adv Setup

Attention: This is Function 10 of ARS-2051F.

5.12.1 Read Error Skip

This function sets the system to ignore any errors during the copying process. Normally if there is an error during copying a warning is displayed on the LCD. By using this function, users can also copy a HDD with errors.

12-01. Adv Setup
Read Error Skip

Press **ENT** to enter the following screen. By default this option is set to OFF. Use the up and down buttons to enable or disable this option.

Read Error Skip
Off

Attention: This is Function 10-02. of ARS-2051F.

5.12.2 Update Firmware

This function is used to update the system's firmware. Download the latest version of the firmware from the Internet at www.acard.com then write it on to a blank CD/DVD/HDD/USB.

12-02. Adv Setup
Update Firmware

Shut down the HDD clone. Restart the system and insert the CD/DVD/HDD/USB port with the latest version of the firmware into the media.

Press **ENT** and the system will begin scanning for a new firmware version. If found, this will be displayed on the LCD as shown below:

Press **ENT** again to begin updating. If the upgrade is successful the system will restart automatically.

Searching F/W ...
Please Wait ...

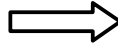

Update F/W X.XX
To X.XX -> Yes

Attention 1: This is Function 10-03. of ARS-2051F.

Attention 2: USB update for some models only, please see page 38 "Appendix B" for more information.

5.12.3 Compare Firmware

This function is used to compare the current system firmware version with the new version the user is upgrading to. This ensures that the downloaded firmware is the latest version. The message "Last update F/W" indicates that it is the latest version.

12-03. Adv Setup
Compare Firmware

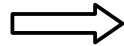

Searching F/W ...
Please Wait ...

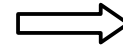

Last update F/W
OK!

Attention: This is Function 10-04. of ARS-2051F.

5.12.4 Quick Erase HDD

This function is used to quickly erase all data on the target HDD with "00" character. Please backup any important data before using this function.

12-04. Adv Setup
Quick Erase HDD

Press **ENT** to enter the following screen. Use the Up and Down buttons to select the HDD to erase:

Quick Erase HDD
ALL/Target CH:*

Press **ENT** again and the LCD will prompt you to confirm the erase operation:

All data will be
lost, Erase? No

Attention: This is Function 10-05. of ARS-2051F.

5.12.5 Full Erase HDD

This function is used to full erase all data on the target HDD with “00” character. Please backup any important data before using this function.

12-05.Adv Setup
Full Erase HDD

Press **ENT** to enter the following screen. Use the Up and Down buttons to select the HDD to erase:

Quick Erase HDD
ALL/Target CH:*

Press **ENT** again and the LCD will prompt you to confirm the erase operation:

All data will be
lost,Erase? No

5.12.6 H/W Diagnostic

Press **ENT** to enter the following screen. This function is used to check that the system is operating normally.

12-06.Adv Setup
H/W Diagnostic

Press **ENT** again to enter the following screen. The LCD will cycle through the test categories as they are performed. The LCD display is tested first, the control panel is tested next (requires manual operation), then followed by the system's internal diagnostics, hardware connection test then the RAM and SD Flash test. All test results are shown on the LCD. This is a simple way to verify that the system is operating normally.

Press **ENT** and the system will begin the tests as shown below:

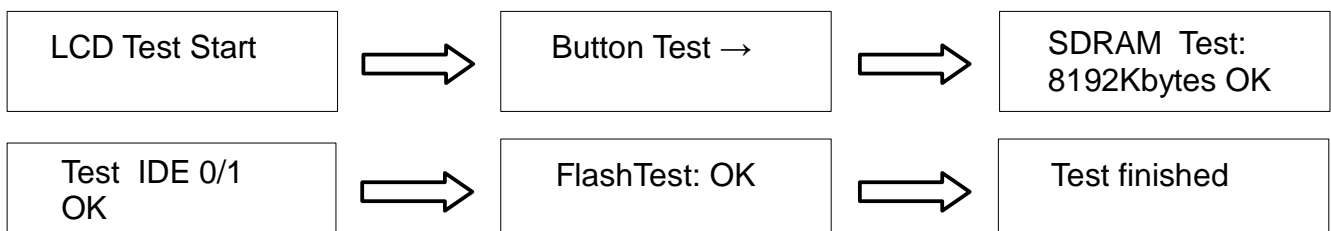

Once the system diagnostics have been completed the "Test finished" message will appear on the LCD.

Attention: This is Function 10-06. of ARS-2051F.

5.12.7 Load Default

Press **ESC** to return to the main menu then use the **ENT** button to select. This function resets all settings to their factory default. This function helps the system recover from errors caused by an illegal operation.

12-07. Adv Setup
Load Default

Press **ENT** to enter the following screen. Use the Up and Down buttons to confirm reset to factory defaults:

Load Default
Config? Yes

If Load Default OK, this will be displayed on the LCD as shown below:

Load Default
Ok

Attention: This is Function 10-07. of ARS-2051F.

5.12.8 Copy HPA

If this function is set to "ON", the system will completely copy the data in a source HDD's host protected area.

12-08. Adv Setup
Copy HPA

The default is "OFF". Use the **ENT**, Up and Down buttons to change this to "On".

Copy HPA
OFF

Attention: This is Function 10-10. of ARS-2051F.

5.12.9 Burn In (ARS-2051F not support)

This function is used to burn test the system reliability.

12-09. Adv Setup
Burn In

Press **ENT** to enter the following screen:

Burn In Mode
Copy & Compare

Use the Up and Down buttons to choose Compare, Async Copy & Cmp and Async Compare, then press **ENT** to confirm.

5.12.10 Detect HDD Delay (ARS-2051F Only)

This function is used to set the time interval between the system's re-scans of all connected HDD devices.

Press **ENT** and the LCD will show the following info:

10-01. Adv Setup
Detect HDD Delay

Press **ENT** then use the Up and Down buttons to choose different time settings (1~60 sec).

Detect HDD Delay
1Sec

5.12.11 Link Option (for USB mode) – requires AEC-4420DX (ARS-2051F Only)

This function is used to decide if 7. USB Mode will be shown in the main menu as pictured below:

10-08. Adv Setup
Link Option

Press **ENT** and the LCD will display the available options as shown below. The default is "Menu On" and 9. USB Mode will appear in the main menu:

Link Option
Menu On

If set to "OFF" using the Up and Down buttons, the 9. USB Mode option will not appear in the main menu.

5.12.12 USB Auto-Link – requires AEC-4420DX (ARS-2051F Only)

This function sets the ARS-2051F to immediately enter USB mode on startup. This allows direct control via PC as shown below:

10-09. Adv Setup
USB Auto-Link

Press **ENT** and the LCD will display the available options as shown below. The default is "OFF":

USB Auto-Link
OFF

5.13 USB Mode (ARS-2051F only)

This option allows a copy controller connected to the host computer's USB port to be operated from the PC.

Choose option 9 from the menu:

9. USB Mode

Press ENT and the LCD will display the corresponding information as shown below:

Switch USB Mode?
NO

Use the Down arrow to select YES then press **ENT** again to switch to USB Mode. The LCD will display the following info:

USB L.H Mode
D1:HDD D2:HDD

Now press **ENT** to switch to stand-alone mode. The LCD will display the following info:

Copy Mode

Chapter 6 Basic Troubleshooting

6.1 LCD

If the LCD blank after the device is turned on, check that the power cable is properly connected and that the power supply is on.

6.2 Error Message

When the system is running a copy operation or hardware diagnostics, if the operation is manually terminated by pressing ESC an error message will be shown by the LCD. This may lead to an illegal operation and cause the device to stop. If this happens, the device must be restarted.

6.3 Hard Disk

If unable to read the hard disk please check that the data and power cables are properly connected.

6.4 Keys

If pressing the keys on the front panel produces no response from the system, the keys may have malfunctioned. Please check the control panel to see if the wiring has come loose.

6.5 Firmware Upgrade

The device can be updated to new versions of firmware through CD/DVD/HDD and USB port (for 5503M/5503H/5505E/5505M/5505H/5509M/2061F only). If unable to update the firmware, check that the firmware was downloaded correctly. A failed firmware upgrade may cause the duplicator to become inoperable. If the system is working normally, do not attempt this operation. If the system is already experiencing problems, please contact your distributor for repairs.

6.6 Startup/Shutdown

Do not suddenly turn off the power while the system is performing an operation. After shutting down normally, wait a moment (usually around 5 seconds) before starting the system again so it can run its self-diagnostics.

6.7 About Copy HPA

The HPA (Host Protected Area) is a hidden data region defined in ATA/ATAPI-4. This area is not usually accessible to software. The SATA HDD Duplicate Controller supports the copying of data from this hidden area.

Appendix A Error Messages List

NO#	Error Messages	Description	Applied to
1	Source Drive Not Exist!	No source HDD exist during operating	Copy, Async Copy, Compare, Async Compare, PreScan Source, Source Size, Copy Size, Tolerance Size
2	User Abort!	Cancel operating	Any function and any time
3	No Drive Exist	No HDD exist during operating	Device Info
4	X Space Not Enough Target Drive Space Not Enough	When source capacity is small than target	Copy, Compare
5	X Space Not Enough Target Drive Fail!	When source capacity is small than target	Async Copy, Async Compare
6	PreScan Fail	Lose SATA connection during copy or bad sector on HDD	PreScan Source
7	Source Drive Read Fail!	Lose source SATA connection on source port during copy or bad sector on source HDD	Copy, Async Copy, Compare
8	Target Drive Write Fail!	Lose target SATA connection on target port during copy	Copy
9	Target Drive Read Fail!	Lose target SATA connection on target port during comparing	Compare
10	Target Drive Fail!	Lose target SATA connection on target port during async comparing	Async Copy, Async Compare
11	Target Drive Not Exist!	No HDD exist during operating	Overwrite
12	One pass One pass failed	Lose SATA connection on SATA port during Overwrite	Overwrite
13	3 pass pass 1 failed	Lose SATA connection on SATA port during Overwrite	Overwrite
14	7 pass 5220.22-M pass 1 failed	Lose SATA connection on SATA port during Overwrite	Overwrite

If you hear the warning signal while the copying function is executing (a beep every 5 seconds), the LCD screen will display the problem status; you may press any button to return to the copy progress screen.

Appendix B Firmware Update via HDD / USB

1. HDD Update

1. Create a 50MB partition (FAT/FAT32/NTFS) HDD.
2. Copy the latest of firmware into HDD.
3. Insert the HDD with firmware to Source port of HDD Duplicator.
4. Execute "Update Firmware" function.

2. USB Update (ARS-2051F / 2055PF / 2061F PCB:5.2 not support)

1. Copy the latest of firmware into USB root directory.
2. Insert the USB with firmware to USB port of HDD Duplicator.
3. Execute "Update Firmware" function.

Appendix C SATA Port Locate&Define

1. ARS-2051F, Red for Source Port

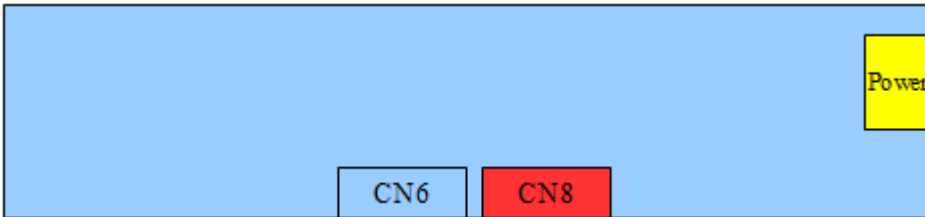

SATA Port#	Channel NO#
CN8	0
CN6	1

2. ARS-5503M, Red for Source Port

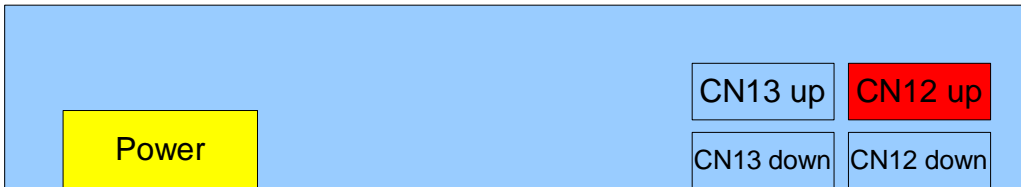

SATA Port#	Channel NO#
CN12 up	0
CN12 down	1
CN13 up	2
CN13 down	3

3. ARS-5503H, Red for Source Port

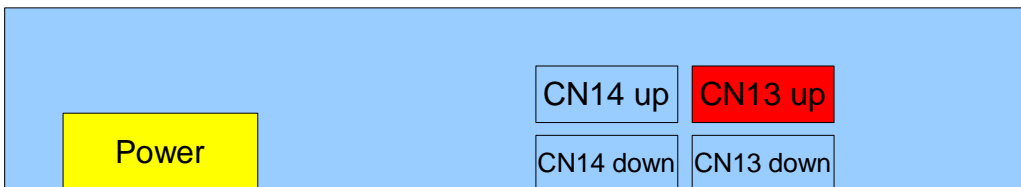

SATA Port#	Channel NO#
CN13 up	0
CN14 up	1
CN13 down	2
CN14 down	3

4. ARS-5505E, Red for Source Port



SATA Port#	Channel NO#
CN12 up	0
CN12 down	1
CN13 up	2
CN13 down	3
CN17	4
CN18	5

5. ARS-5505M, Red for Source Port

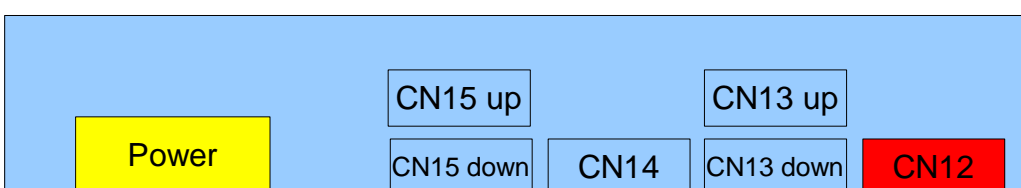

SATA Port#	Channel NO#
CN12	0
CN14	1
CN13 up	2
CN15 up	3
CN13 down	4
CN15 down	5

6. ARS-5505H, Red for Source Port

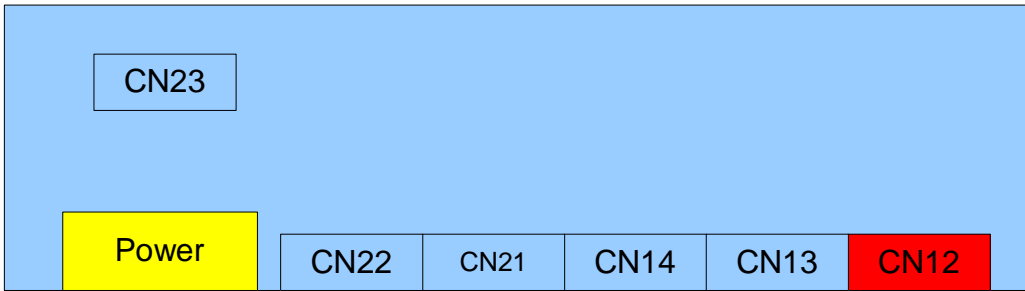

SATA Port#	Channel NO#
CN12	0
CN13	1
CN14	2
CN21	3
CN22	4
CN23	5

7. ARS-2055PF (PCB: 5.2), Red for Source Port

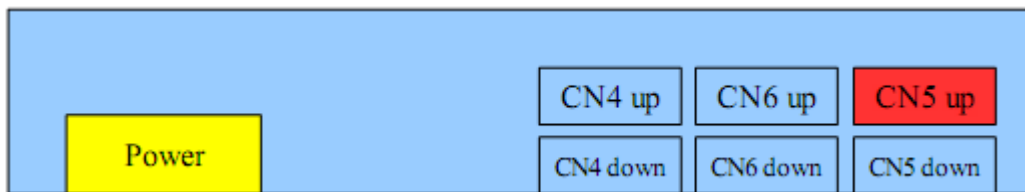

SATA Port#	Channel NO#
CN5 up	0
CN5 down	1
CN6 up	2
CN6 down	3
CN4 up	4
CN4 down	5

8. ARS-5509M, Red for Source Port

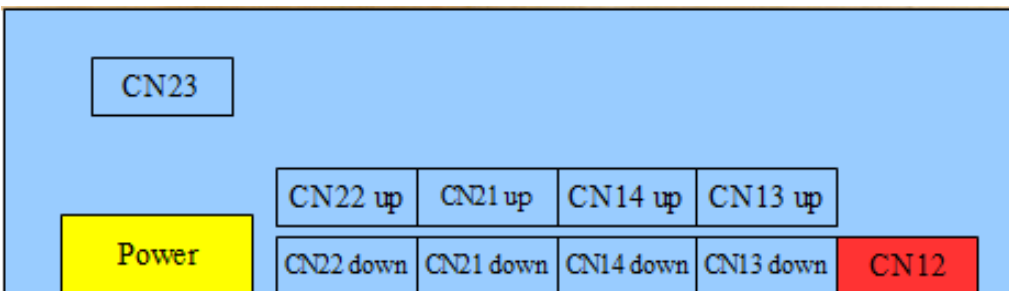

SATA Port#	Channel NO#
CN12	0
CN13 up	1
CN13 down	2
CN14 up	3
CN14 down	4
CN21 up	5
CN21 down	6
CN22 up	7
CN22 down	8
CN23	9

9. ARS-2061F (PCB: 5.4), Red for Source Port

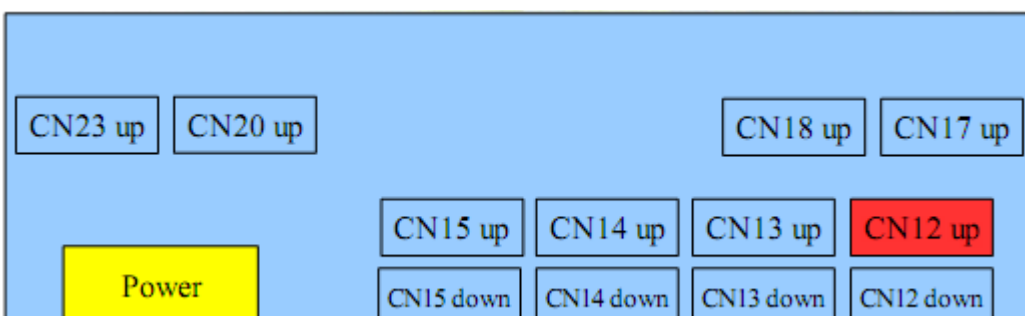

SATA Port#	Channel NO#
CN12 up	0
CN12 down	1
CN13 up	2
CN13 down	3
CN14 up	4
CN14 down	5
CN15 up	6
CN15 down	7
CN17	8
CN18	9
CN20	10
CN23	11

Appendix D ARS-2051F with AEC-4420DX installation

Configuring ARS-2051F HDD/SSD Duplicator Controller and AEC-4420DX USB PCB (Printed Circuit Board) to work with computer:

Please have the ARS-2051F HDD/SSD Duplicator Controller/ duplicator tower powered off and plug in all the necessary cables:

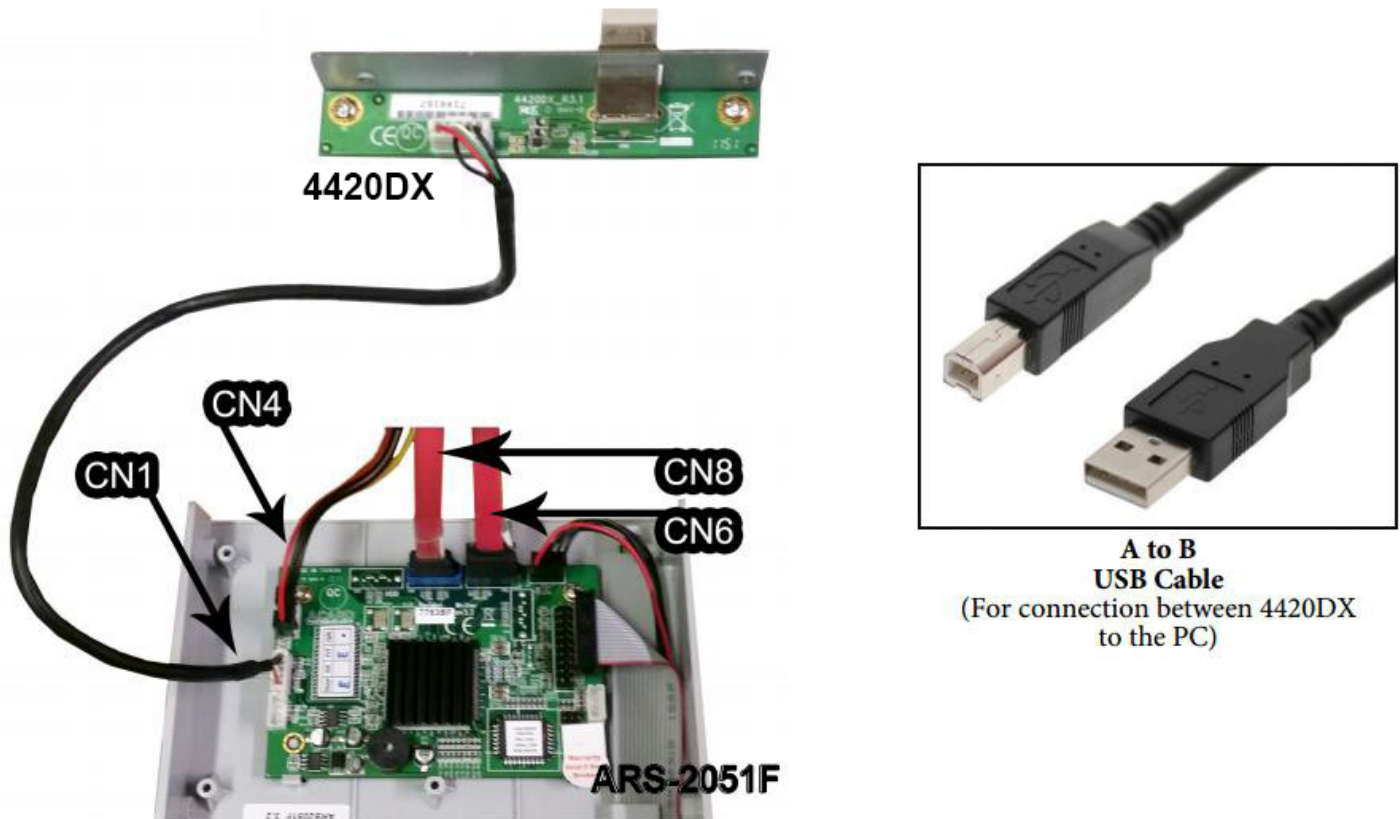

1. Sata cables (CN8, CN6)

- CN8 port (blue) needs to be connected to the master hard drive
- CN6 port (black) needs to be connected to the target/writer hard drive

2. USB PCB (CN1)

- CN1 port (white) needs to be properly connected with the 4420DX USB PCB.
Also, connect an A to B USB cable (not included, see framed photo pictured above) from the 4420DX USB PCB to the PC's USB port.

3. Power (CN4)

- CN4 port (white) needs to be properly connected to the power supply

With all the necessary cables connected (including power connections to the hard drives), please turn on the ACARD controller and/or duplicator system. On default, the controller is in USB Mode because AEC-4420DX USB PCB is detected by Windows Operating System (OS). If not, menu 9 will enable USB Mode.

Attention:

- For more options (including utilization of Advance menu) and to exit USB Mode:
- Press the arrow up or down key on the controller until COPY MODE appears



- Now press the green ENT button
"Back to SA mode?" (SA means Stand Alone) will appear:

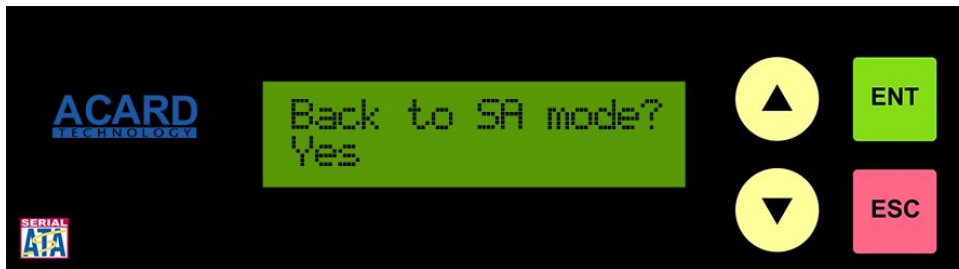

- Next use the arrows to select "Yes". This will exit USB Mode
(By physically pulling the A to B USB cable out from either the PC's USB port or AEC-4420DX's USB PCB will cause the copy controller to exit USB Mode)

To return to USB mode:

- Use the arrow keys to search for menu 9 USB Mode and enable it (If the USB cable is physically disconnected to disable USB Mode, please reconnect the cable before enabling USB Mode.):



Once all cables are connected and the devices are powered on, the Device Manager in Windows OS will recognize ARS-2051F HDD/SSD Copy Controller's attached hard drives and automatically begin installing drivers to the computer. As a result, the hard drives that are connected to the controller will appear in Device Manager and in the "Computer" folder.

The following two screenshots are of that result below:

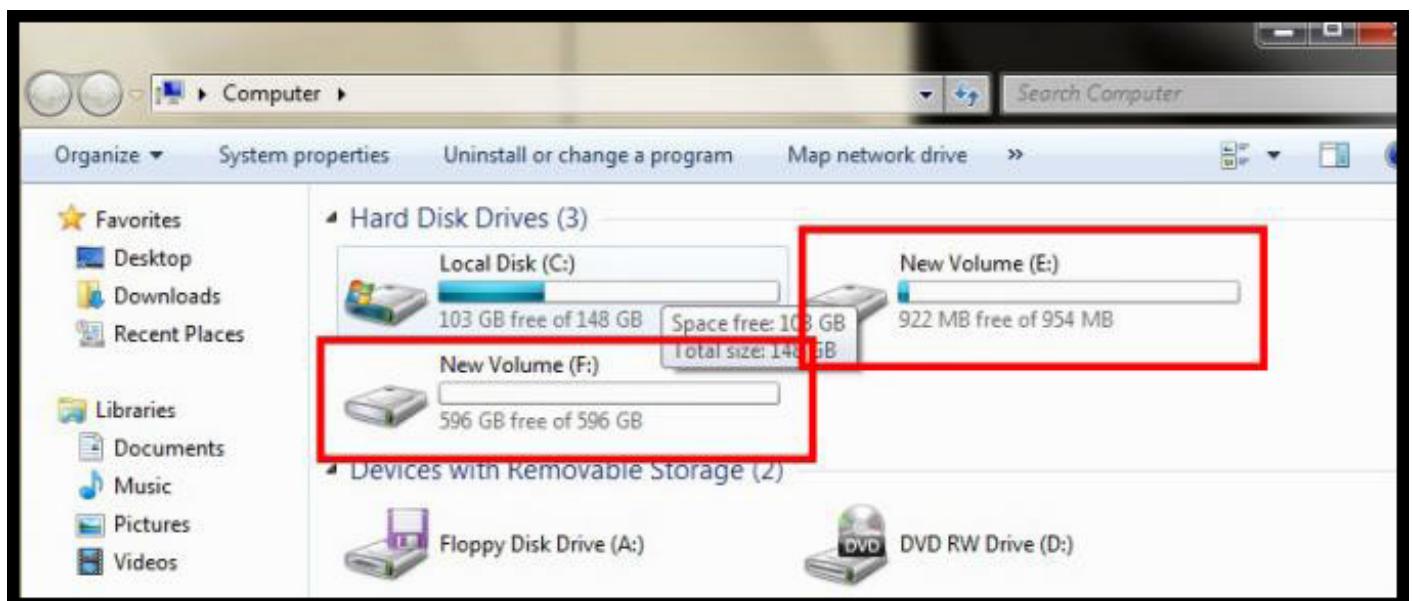
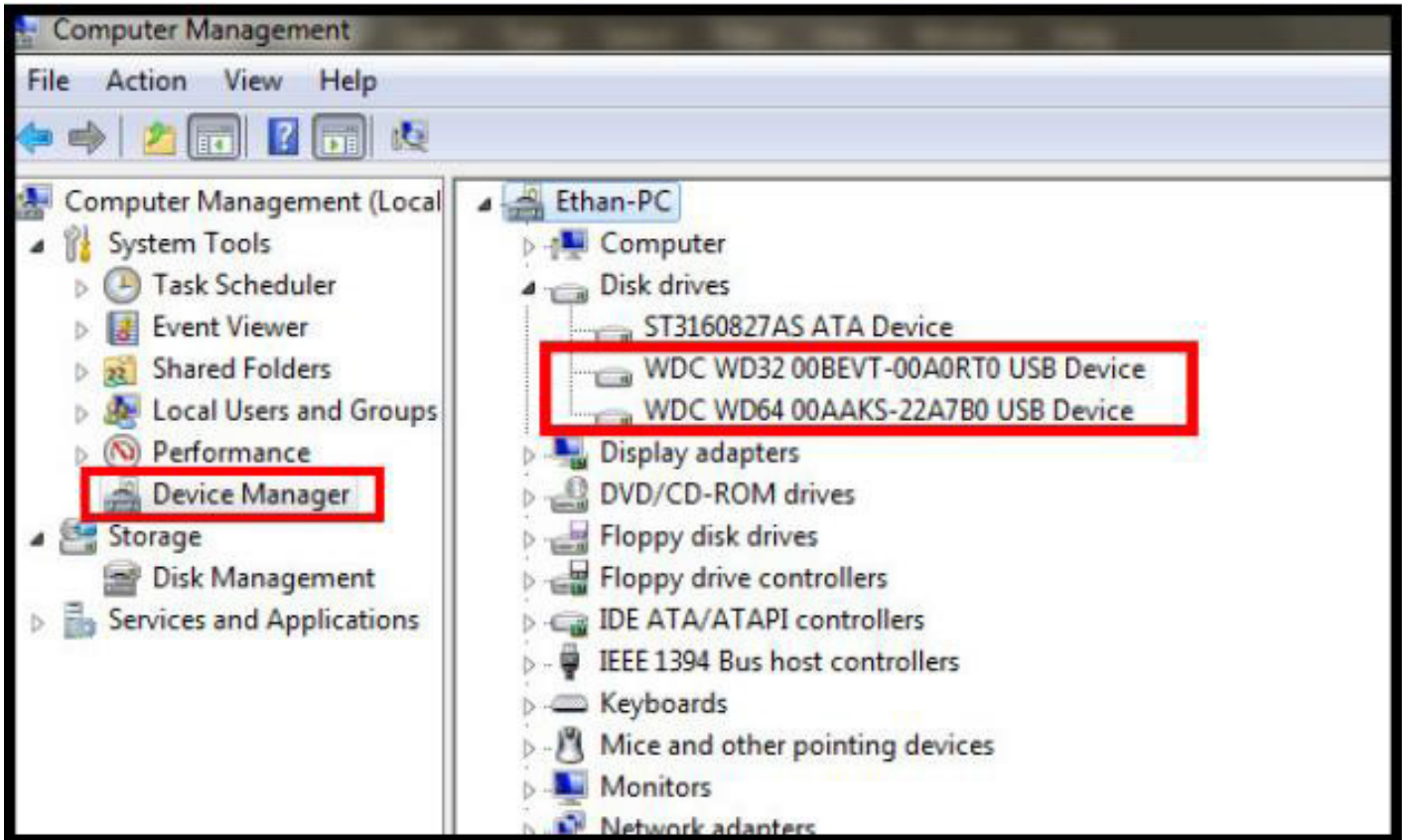

If the ARS-2051F HDD/SSD Copy Controller's attached hard drives are appearing in the Device Manager and the "Computer" folder, the newly formatted hard drives are ready for use.

However, if ARS-2051F HDD/SSD Copy Controller's attached hard drives are not appearing in Device Manager and/ or "Computer" folder, please continue to the next step to initialize them.

1. To confirm if the hard drives are initialized/ formatted correctly for use, please navigate to Disk Management and format/ partition the hard drives to its' capacity configurations.
(Beware, please be sure to save any files needed on the hard drives before formatting)

The following screenshot is an example of unformatted/ unpartitioned hard drives in Disk Management:

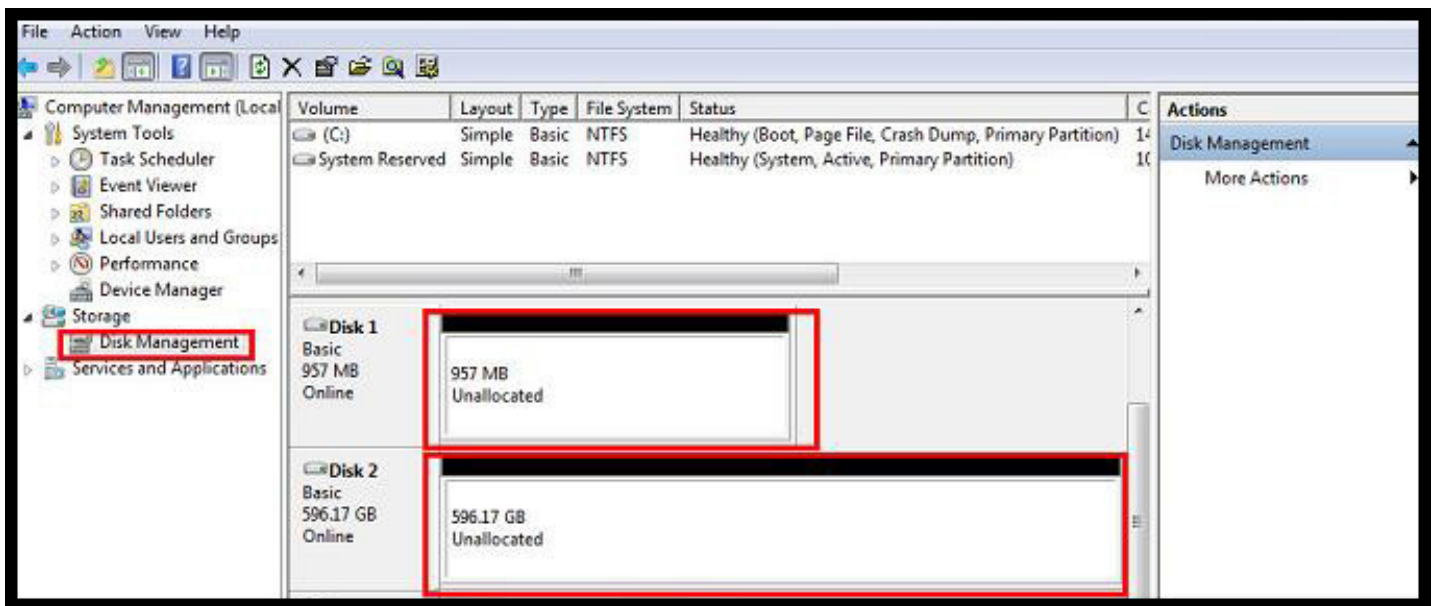

ARS-2051F HDD/SSD Copy Controller's attached hard drives are not recognized in the "Computer" folder:

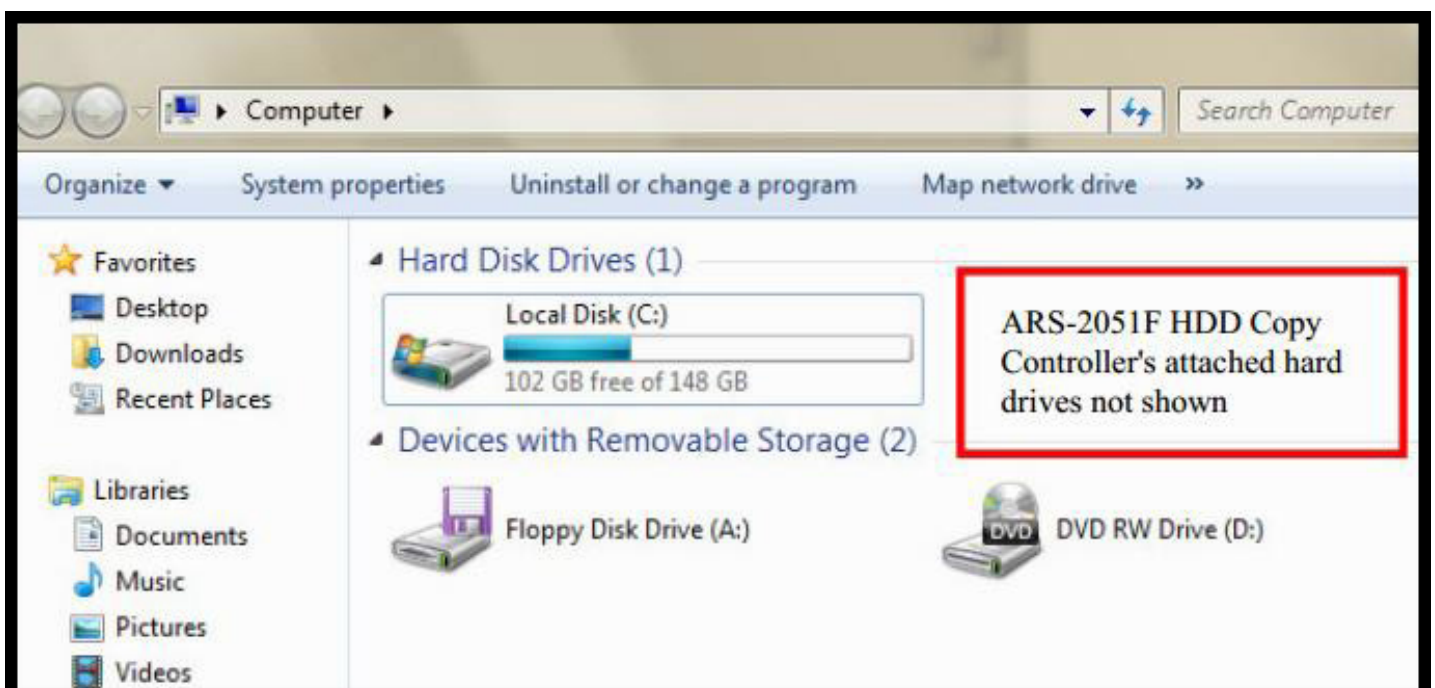

2. Next, format the ARS-2051F HDD/SSD Copy Controller's attached hard drives from Disk Management will allow the computer to recognize the hard drives and they will appear in the "Computer" folder as New Volume. See pictures below:

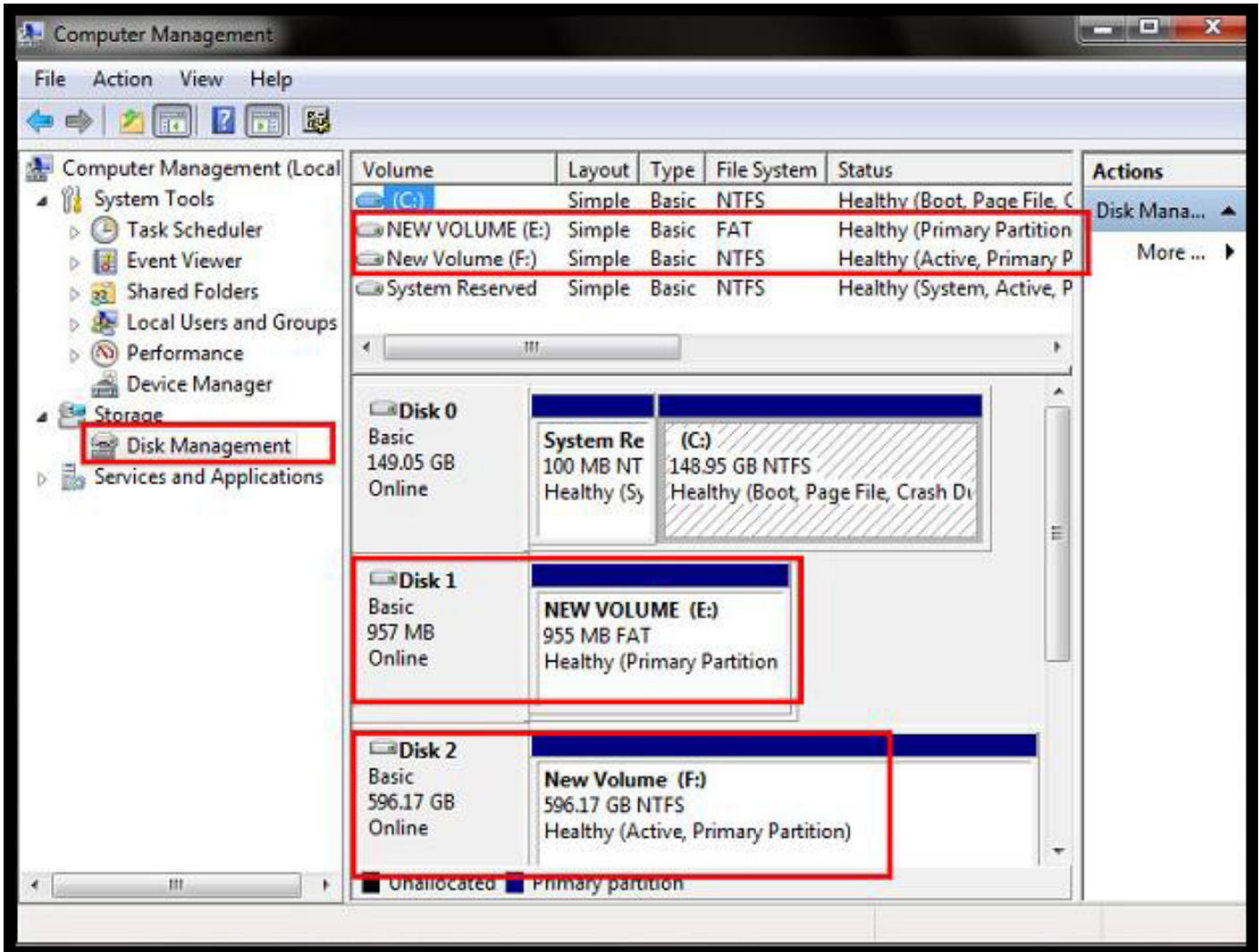

The newly formatted hard drives are now ready for access.



Technical Support Form

Email address: support@acard.com

Website: http://www.acard.com

Model Name* (ex: ARS-5503H)		Firmware version*	
System Configuration			
Motherboard/System model*			
SCSI host adapter/chip brand & model*			
SCSI host BIOS version			
Other I/O card*			
Operating System*			
SATA HDD brand & model*			
SATA HDD capacity			
SATA HDD firmware			
Problem description*			

『 * 』 is required